

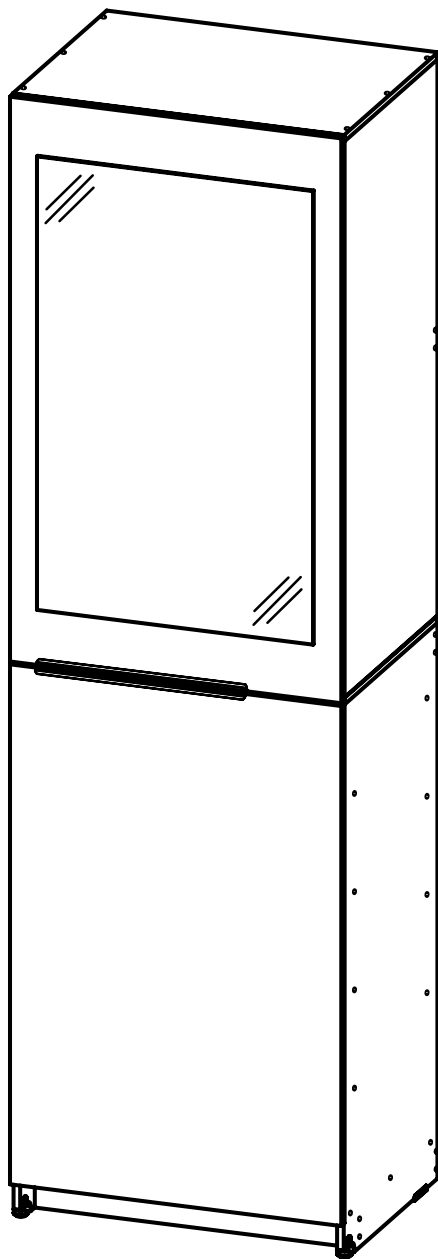

ZAPATERA CON COLGADOR



capelli[®]
diseño y funcionalidad

Gracias por adquirir nuestros productos. Por favor, **lea todo el instructivo ANTES** de comenzar el armado de su nuevo mueble.

Contenido de la Caja

TA	Tapa	1 pz	PS	Puerta Superior	1 pz
CSD	Costado Sup. D	1 pz	PI	Puerta Inferior	1 pz
CSI	Costado Sup. I	1 pz	ZO	Zocolo	3 pz
ED	Entrepaño Div.	1 pz	ZM	Zocolo Medio	1 pz
CID	Costado Inf. D	1 pz	FO	Forro	1 pz
CII	Costado Inf. I	1 pz	FI	Forro Inferior	1 pz
BA	Base	1 pz	EN	Entrepaño	4 pz

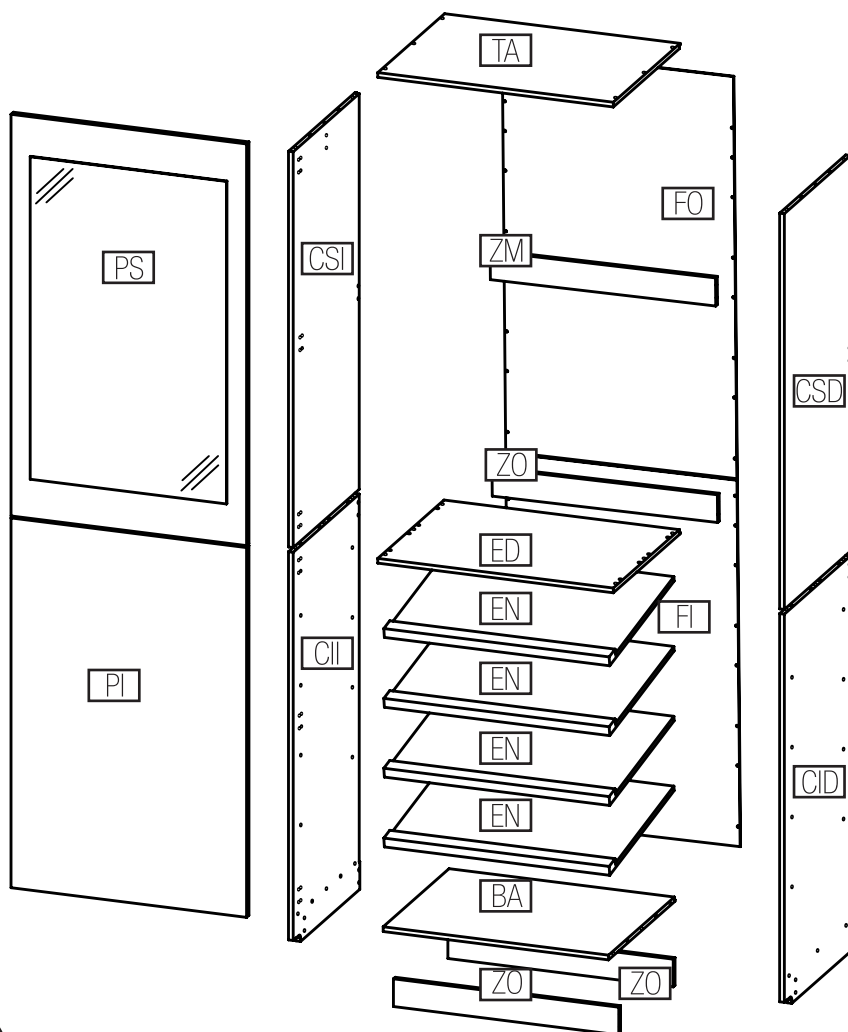

Herrajes

01
06pz



Caja minifix
12mm

02
06pz



Perno
galvanizado 24mm

04
06pz

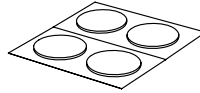

Tapa autoadherible
para Minifix 12mm

09
08pz



Taquete de
Madera 6x30mm

10A
12pz

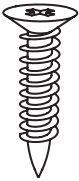

Pija
6x5/8"

10B
04pz

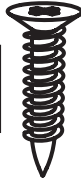

Pija
6x5/8" Negra

11
32pz

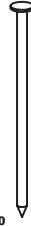

Clavo

13
48pz



Tornillo
Confirmat 5x38mm

**PUEDEN CONTENER UNA
U OTRA**

14
44pz



Tapa para Confirmat
5x38mm

14
44pz

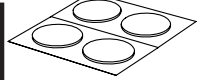

Tapa Autoadherible
para Confirmat 5x38mm

18
02pz



Taquete Plástico
1/4"

19
02pz



Tornillo
8x1 1/2"

23
02pz



Brida Negra

29
02pz



Placa de Unión

31
01pz

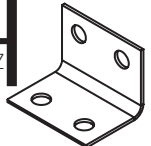

Escuadra Metálica

34
01pz



Tubo Ovalado
567mm Negro

36
02pz

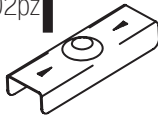

Resbalon
Metálico 12mm

37
3Juegos



Bisagra
Sobrepuesta

38
02pz



Jaladera Platino
Negra

66
02pz

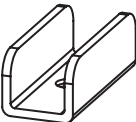

Soporte Nivelador

67
02pz

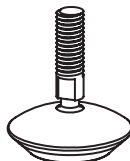

Tornillo Nivelador

74
34pz



Tornillo Griper
6 x 1/2"

83
04pz



Goma Antigolpes

Herramientas Necesarias

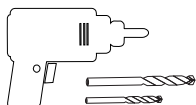
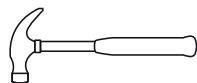
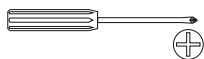
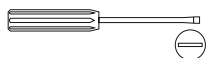

Recomendaciones Generales

Lea éste instructivo en su totalidad antes de iniciar el armado de su mueble.

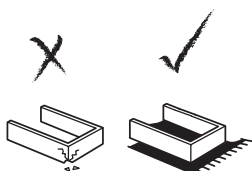

Proteja su superficie de trabajo para evitar dañar el acabado del mueble.

Pida ayuda. Este mueble está diseñado para armarse entre 2 personas.

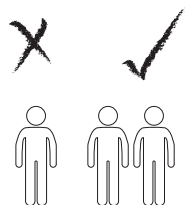

I

Materiales:

BA

09
04pz

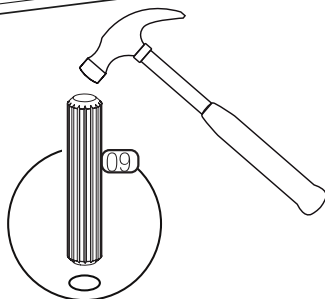
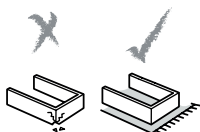
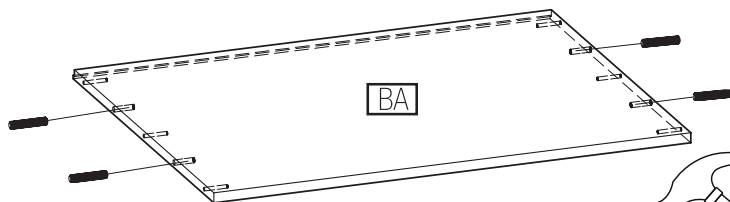

2

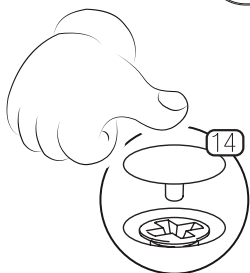
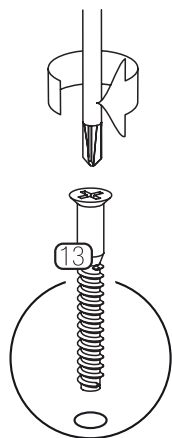

Materiales:

CID	ZO	X3
CI	EN	X4
BA		

13
34pz



14
34pz

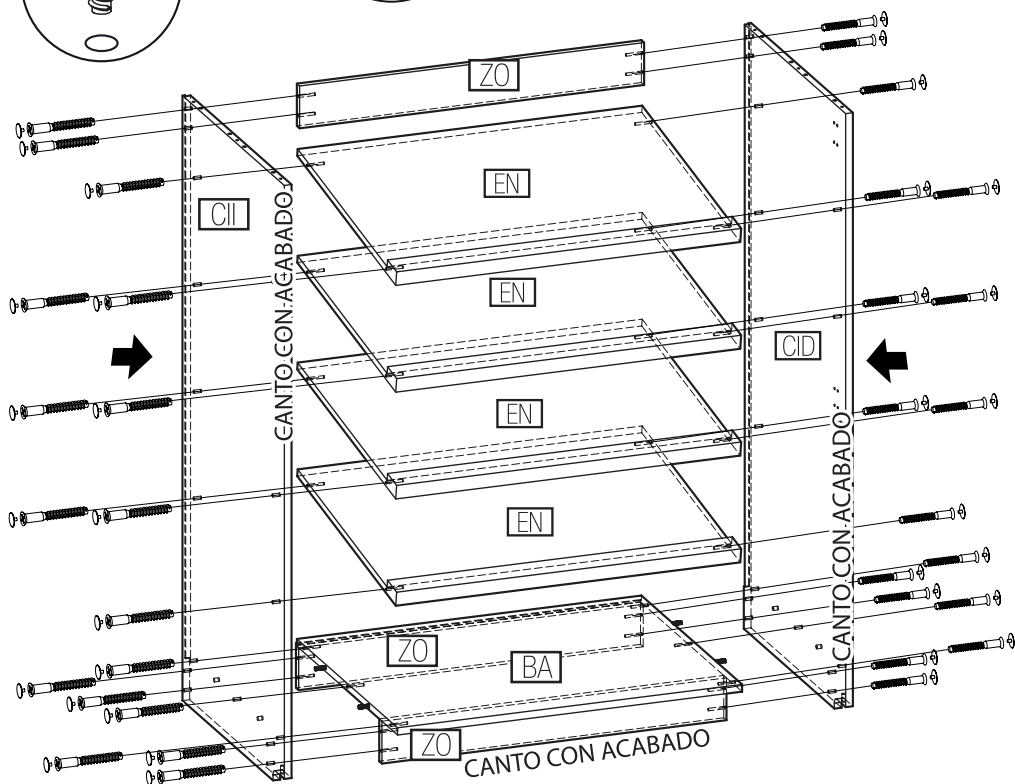
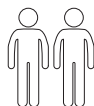

Colocar como se indica

3

Materiales:

ED

13
04pz

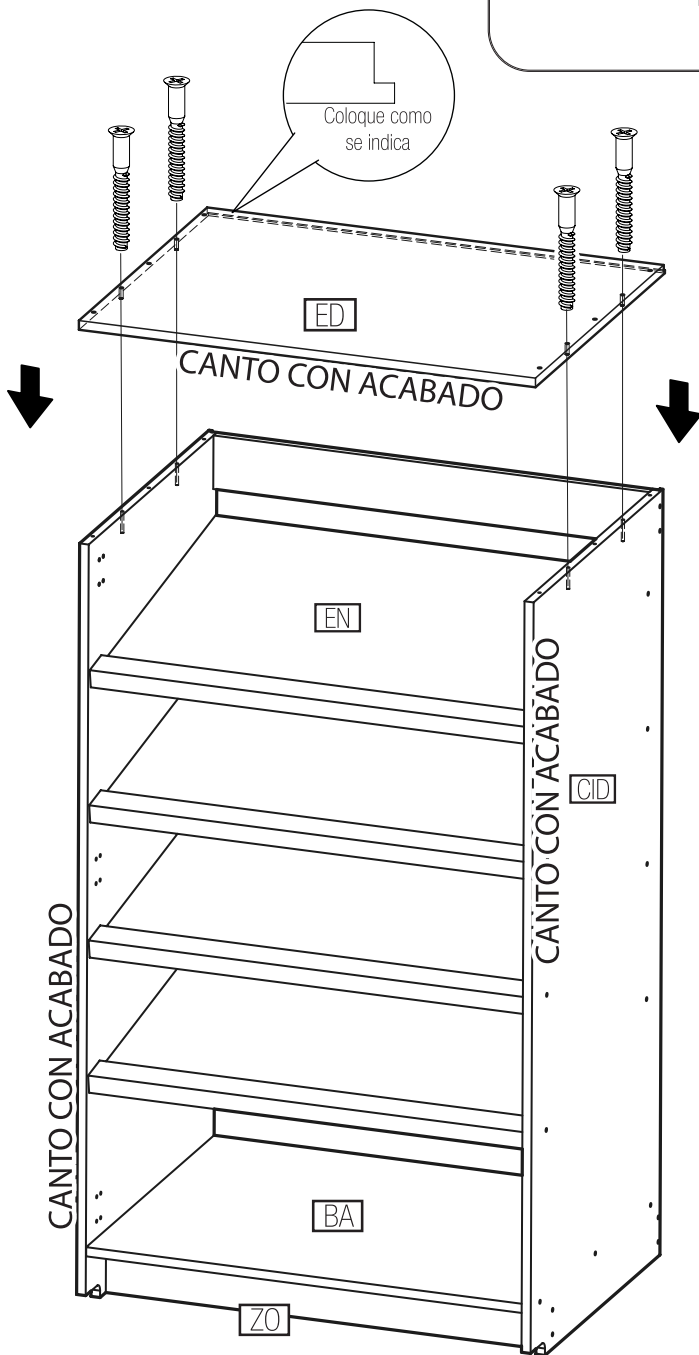
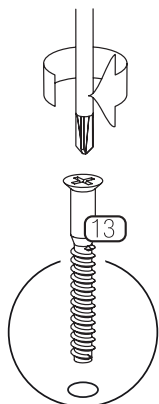

4

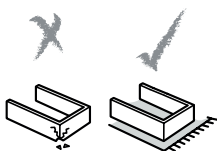
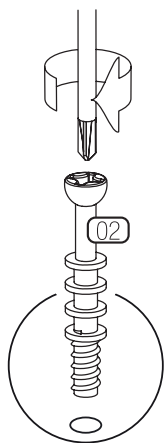

Materiales:

02
06pz

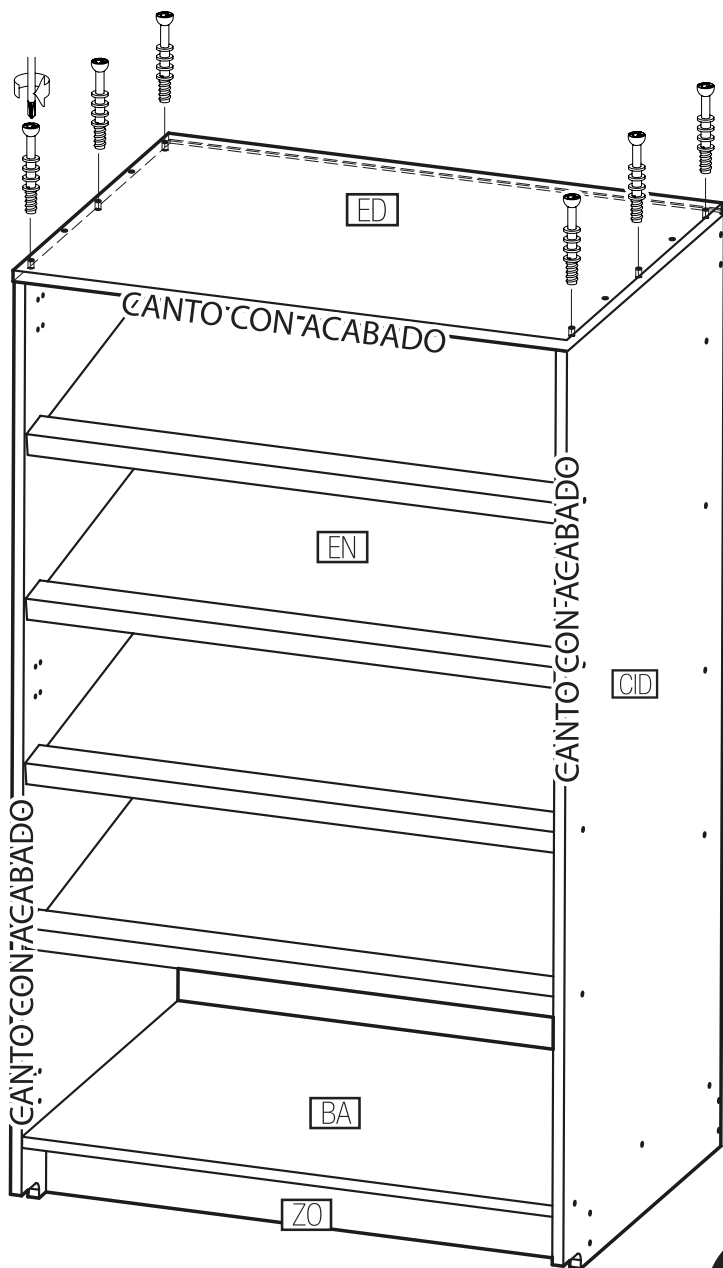

5

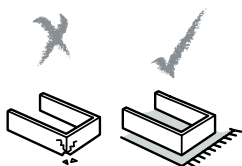
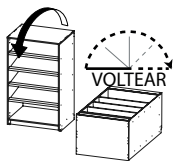

Materiales:

FO 11
16pz



NATURAL

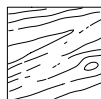

ACABADO

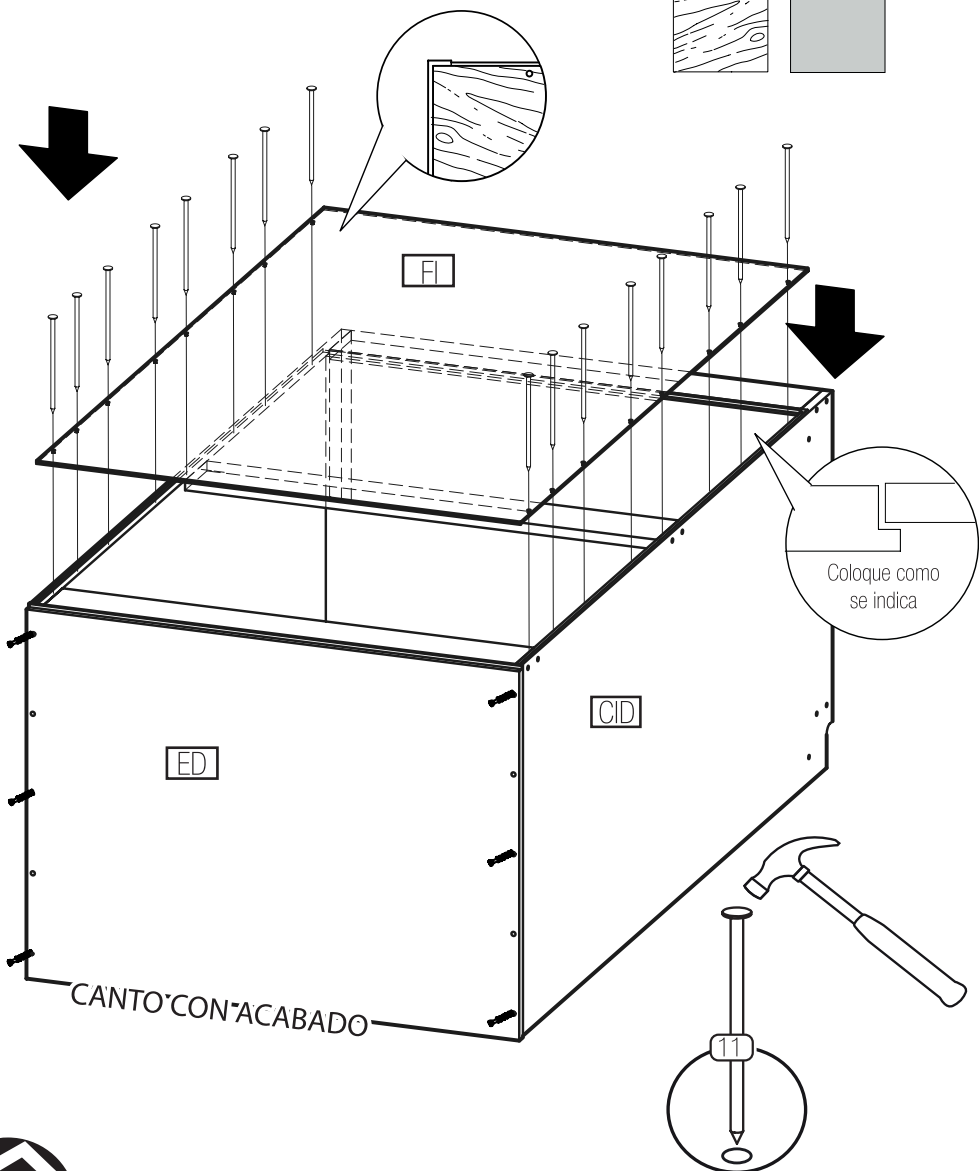
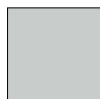

6

Materiales:

36
02pz

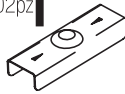

66
02pz

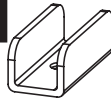

67
02pz

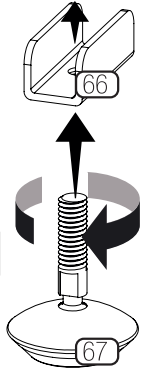
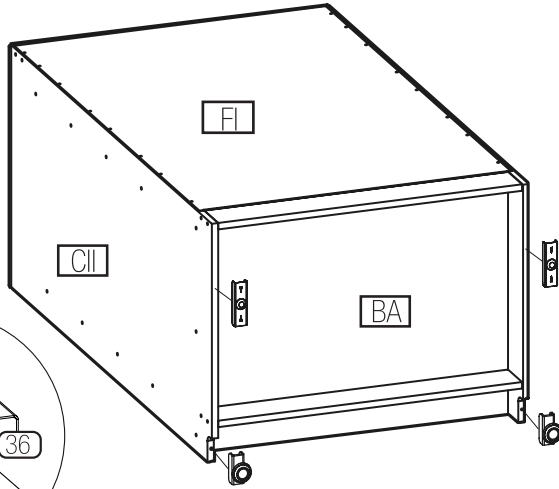
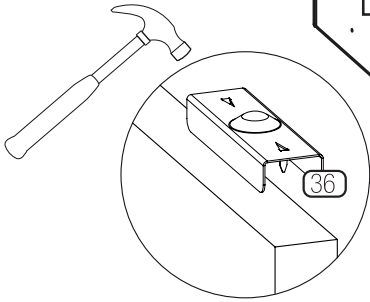
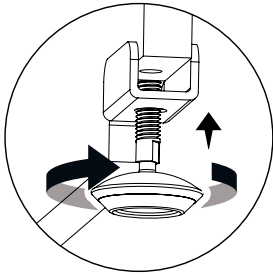
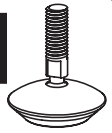

7

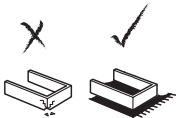

Materiales:

CSD
CSI

74
04pz



23
04pz

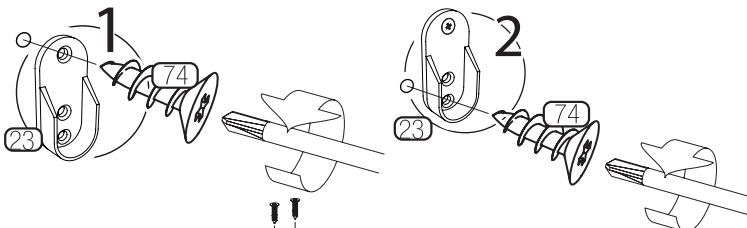

CANTO CON ACABADO

9

8

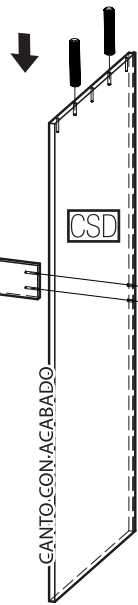
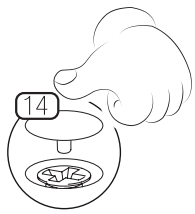
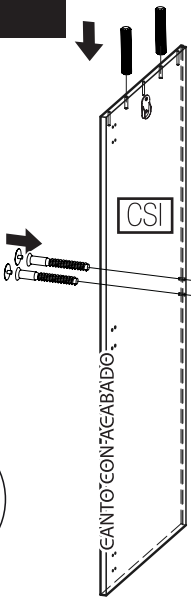
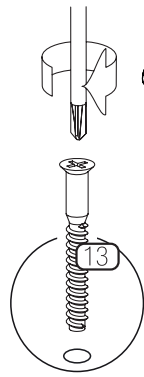

Materiales:

CSD	14	
CSI	04pz	
ZM		
	13	
	09	
	04pz	

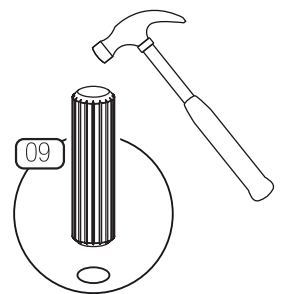

9

Materiales:

TA	
13	
06pz	
14	
06pz	

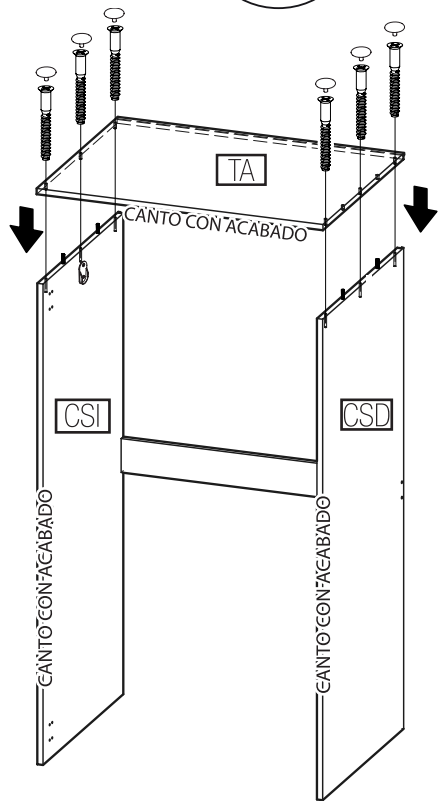
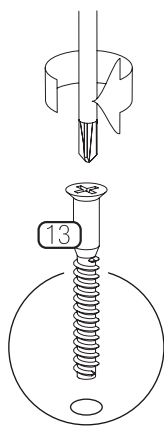
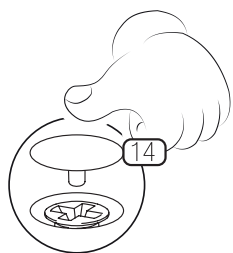

10

10

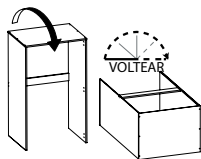

Materiales:

FO $\frac{11}{16\text{pz}}$

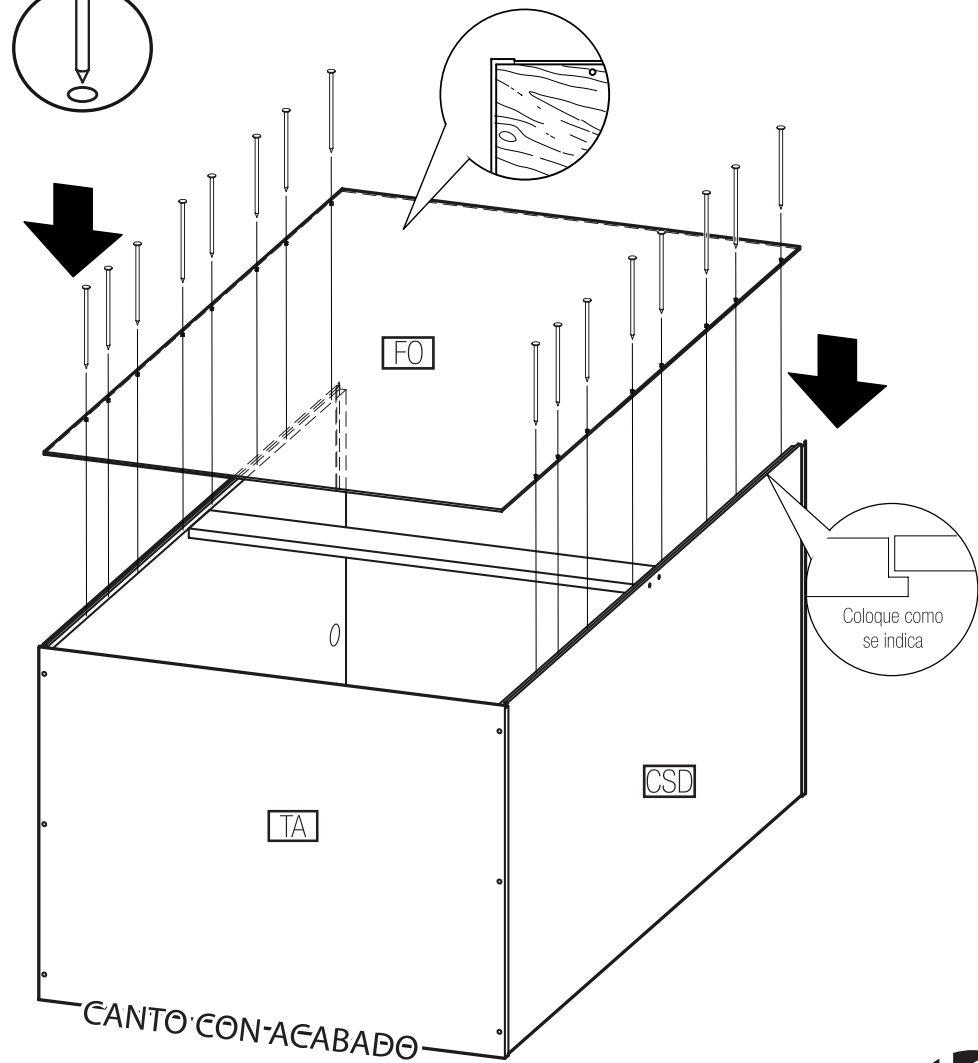
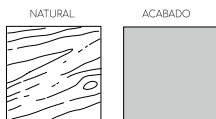
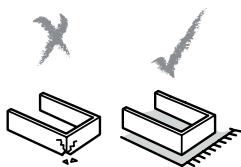
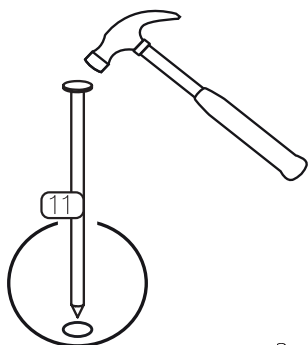

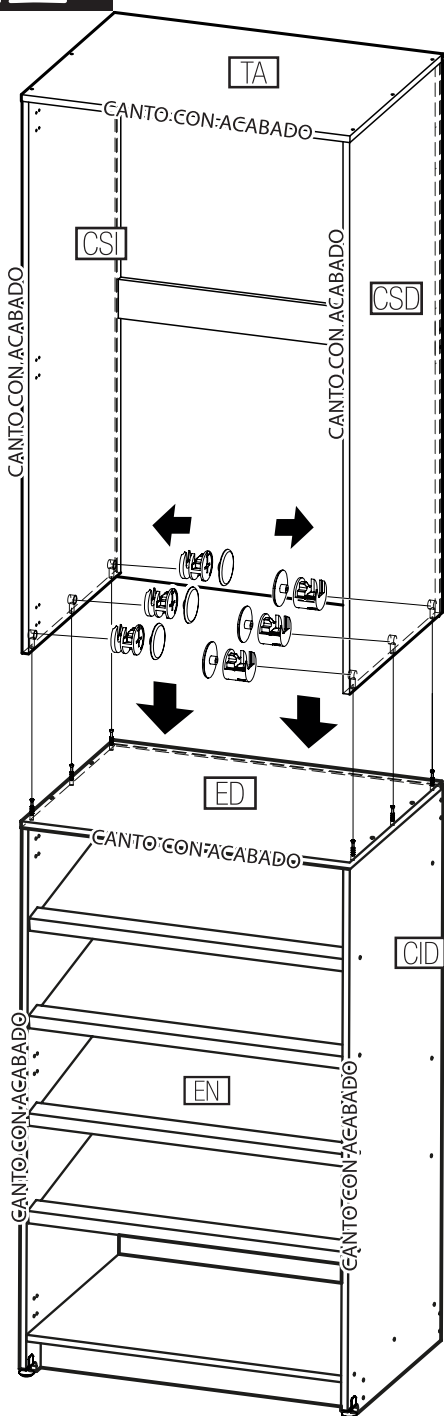

Materiales:

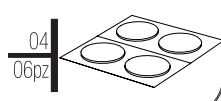

Colocar minifix con la flecha apuntando hacia el perno

1

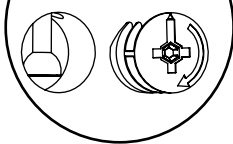

2 Atornillar hacia la derecha 95°

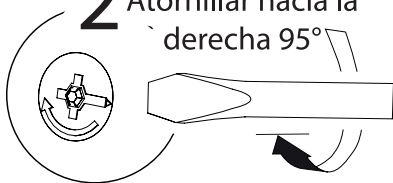

3 Colocar tapa

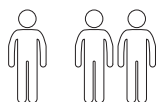
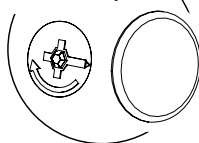

12

Materiales:

34
01pz

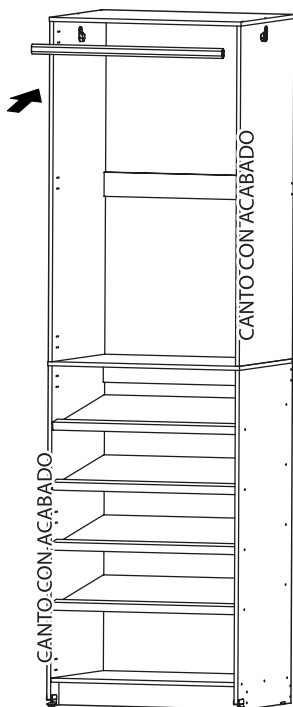
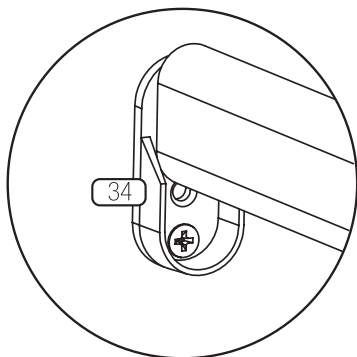

13

Materiales:

37
3 Juegos

PS

PI



10A
12pz

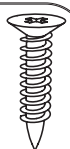

NEGRA

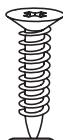

10A

10B

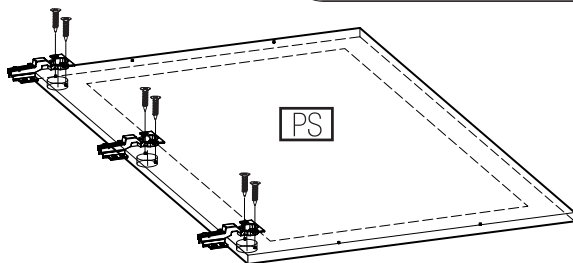
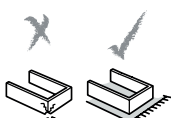

NO usar atornillador eléctrico

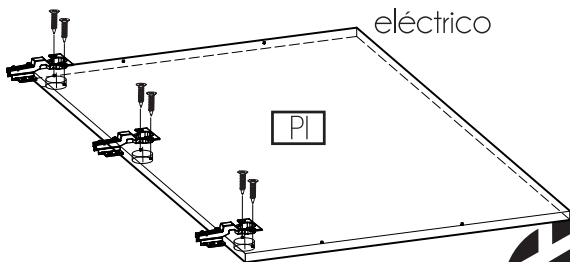
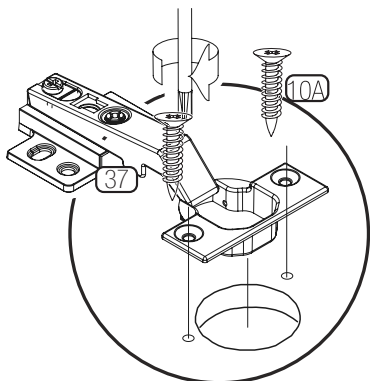

Materiales:

PS

38
02pz

PI



10B
04pz



83
04pz

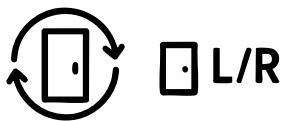
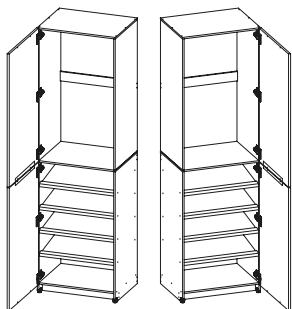

Puerta reversible:
Es posible colocarla del
lado derecho o izquierdo
Se adapta a tu espacio

L

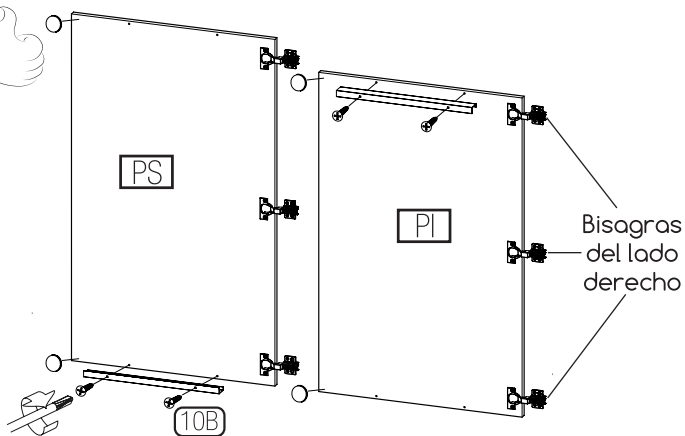
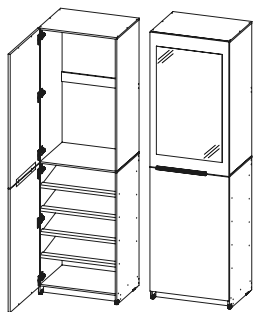

R

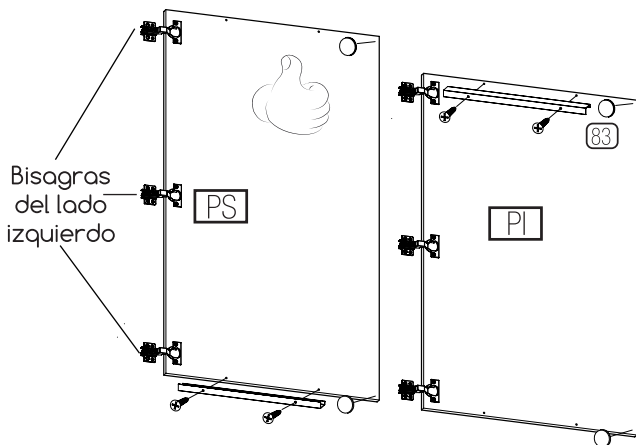
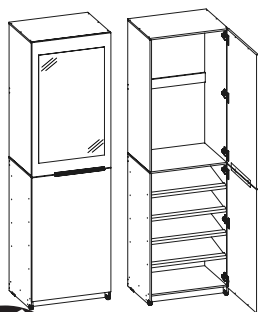

15

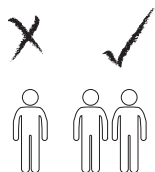

Materiales:

74
24pz



NO usar atornillador eléctrico
eléctrico

**Repetir este paso para
las dos puertas**

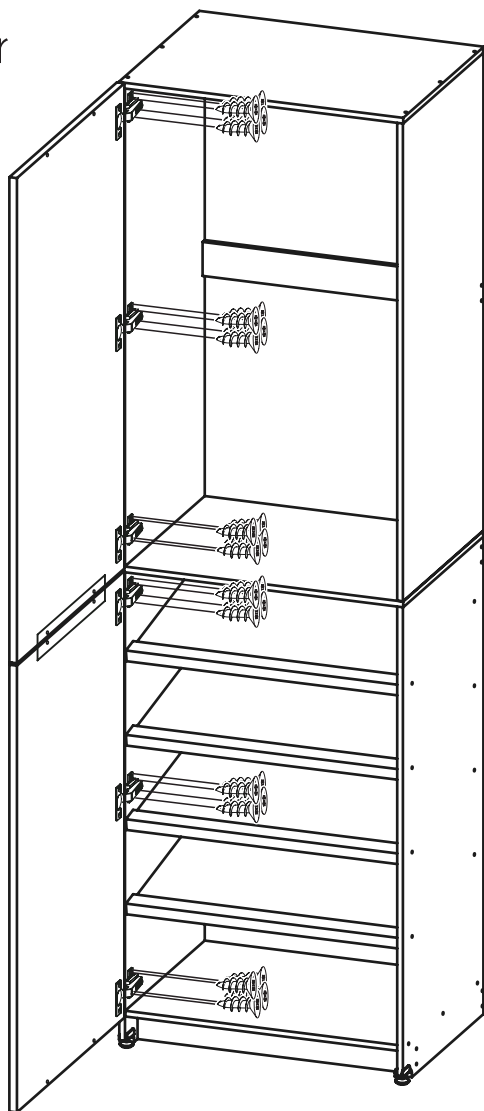
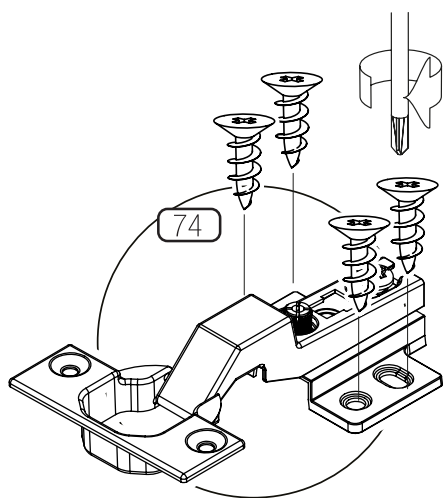

AJUSTE LAS BISAGRAS

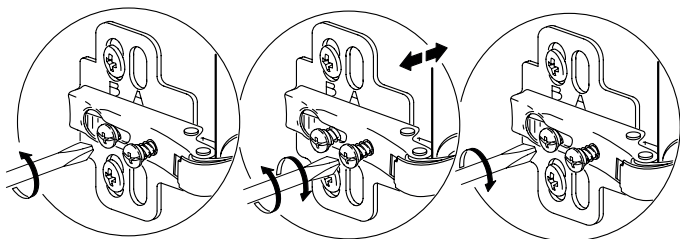
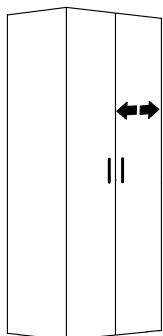
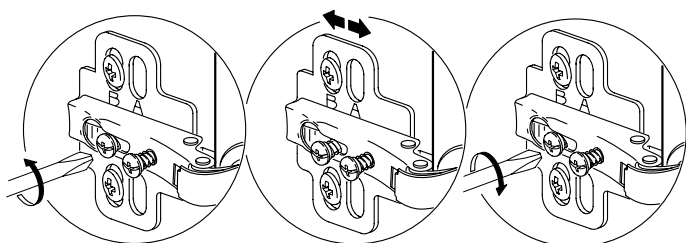
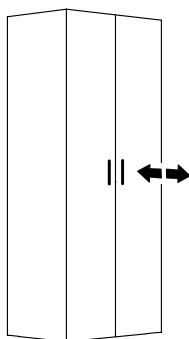
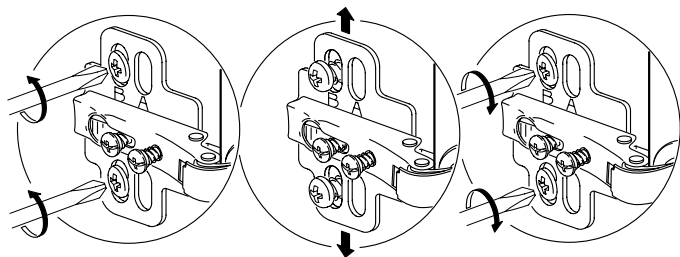
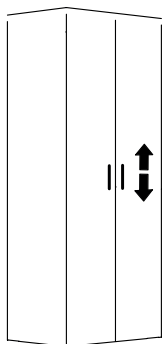

Ajuste de puertas

Montaje a pared

Paso 1

Marque la pared con un lápiz.

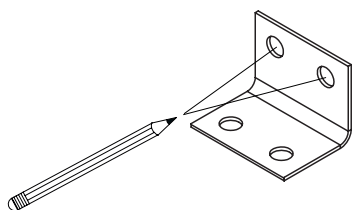

Materiales:

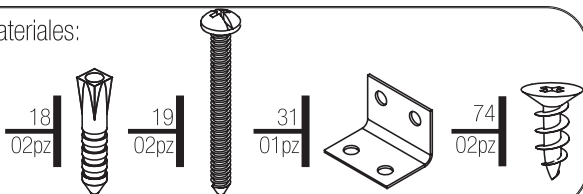

Paso 2

Barrene la pared con una broca de 1/4". Posteriormente, haga un pequeño barreno guía de poca profundidad en la tapa del clóset con una broca delgada.

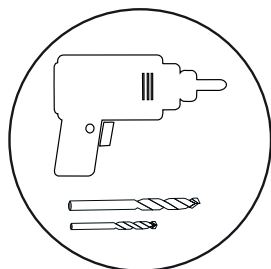

Paso 3

Inserte los taquetes en la pared.

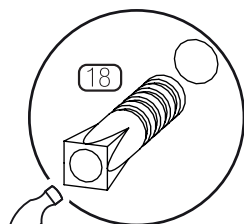

Paso 4

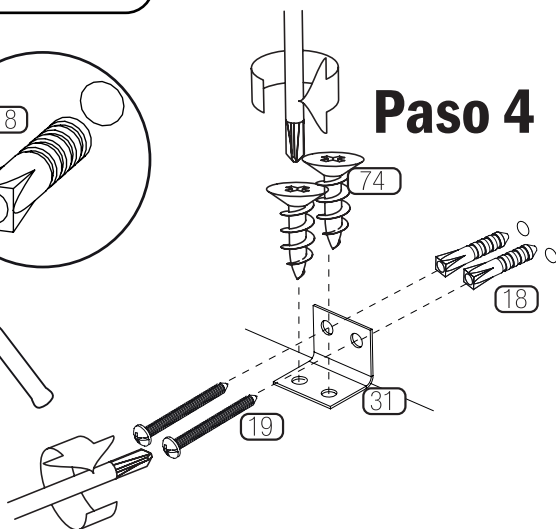

Los herrajes de anclaje incluidos en la caja están diseñados para muros convencionales de tabique rojo. Consulte a un experto para instalación en muros de otros materiales.

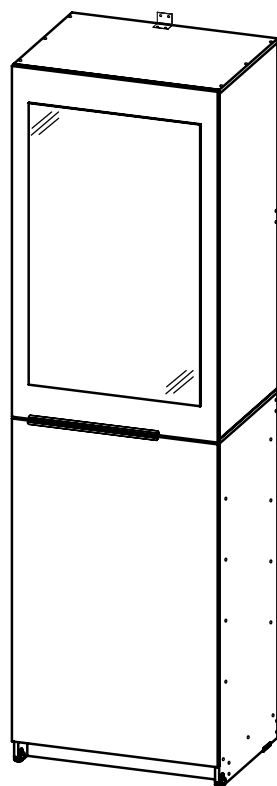

Unión

En caso de haber adquirido más de un módulo de la **Línea Platino** debe unirlos con las placas de fijación y las pijas como se muestra en el dibujo.
¡Disfruta de tu nuevo mueble!

Materiales:

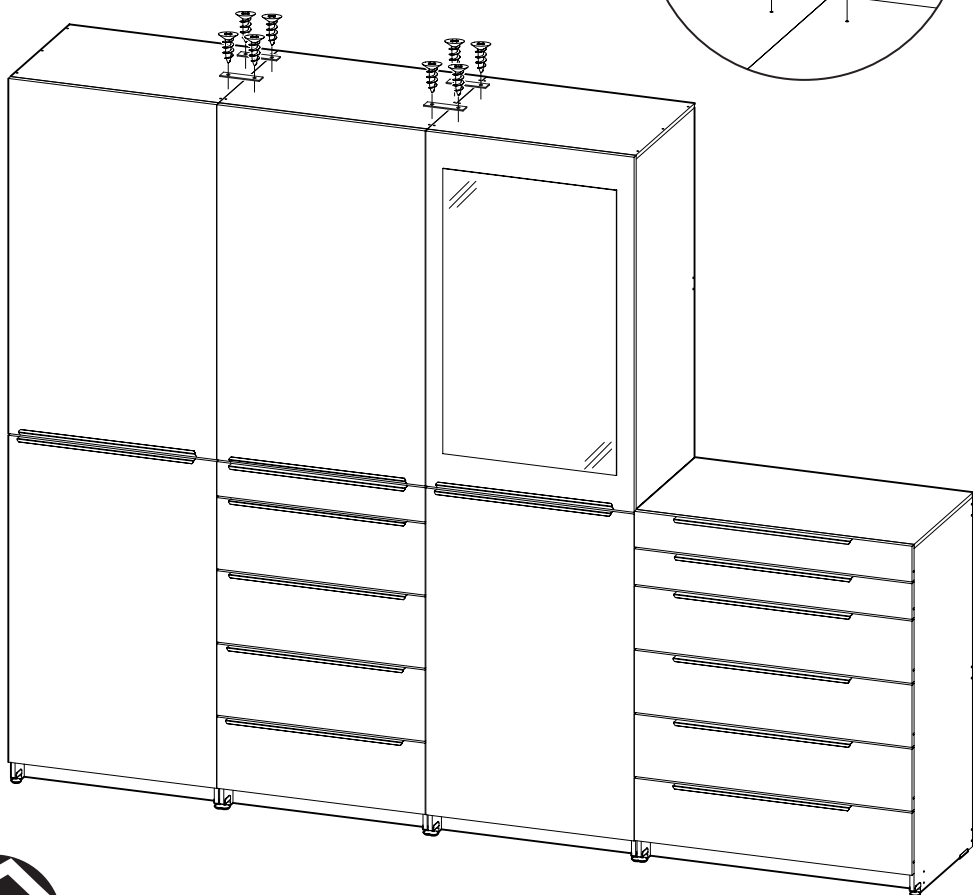
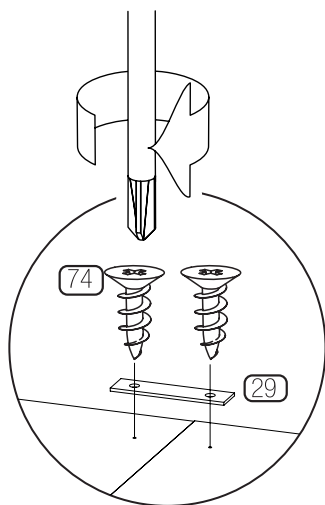
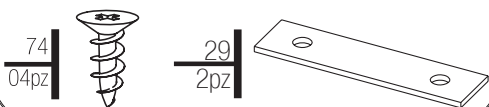

Configuraciones

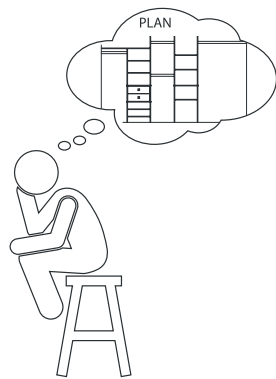

Configuraciones

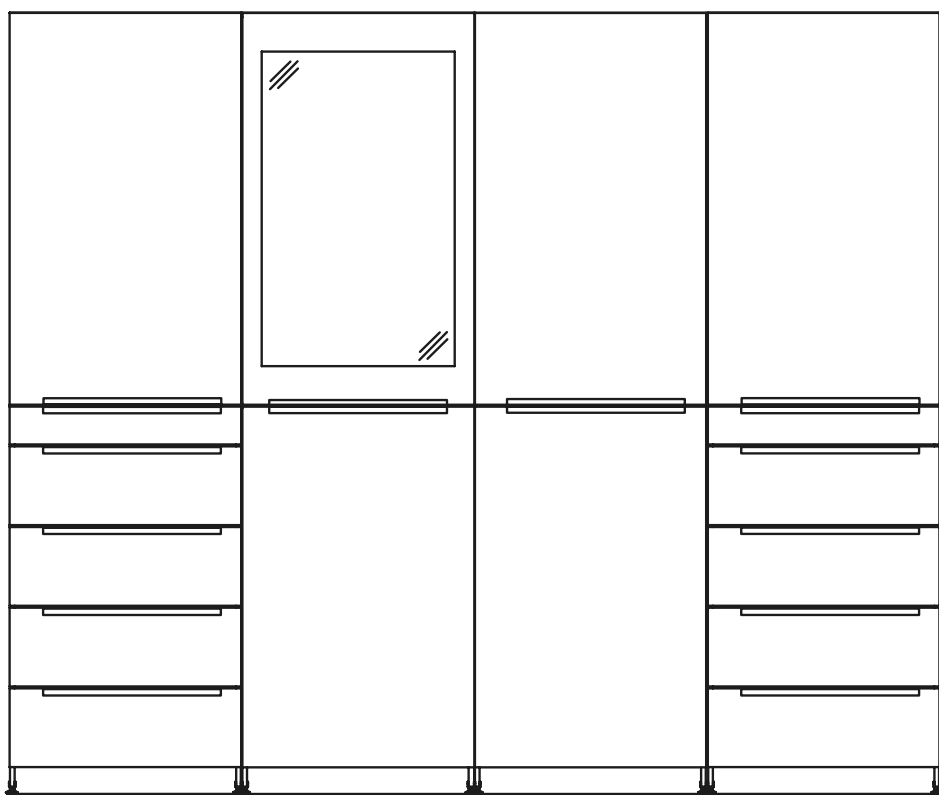
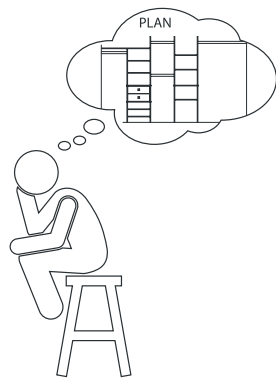

Configuraciones

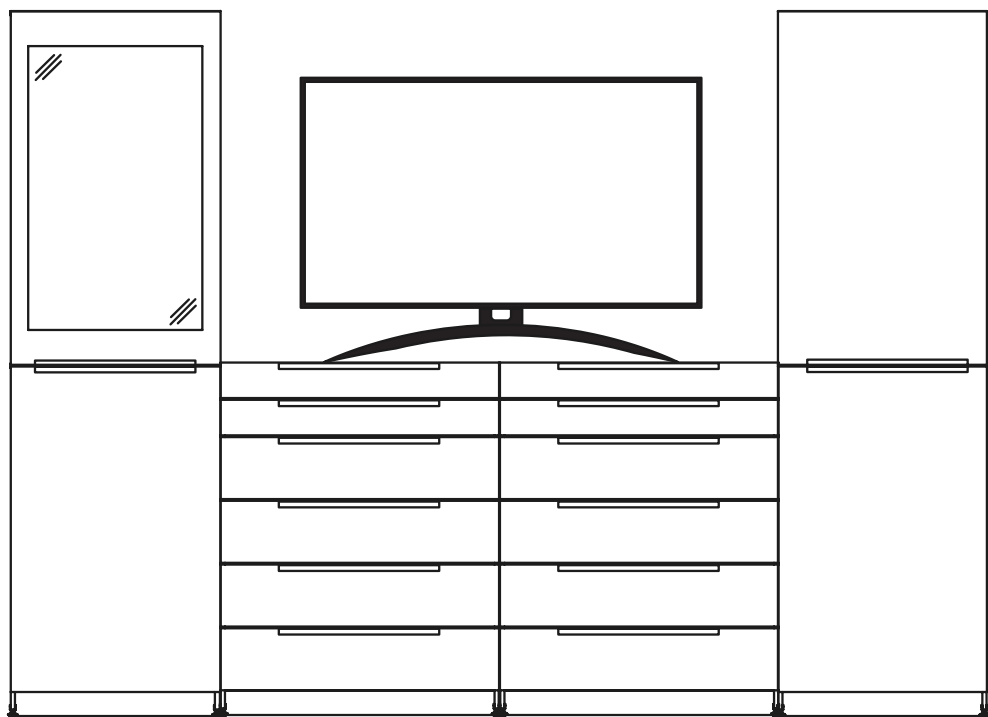
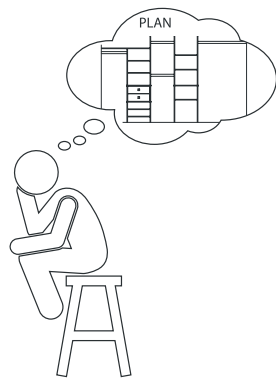

Configuraciones

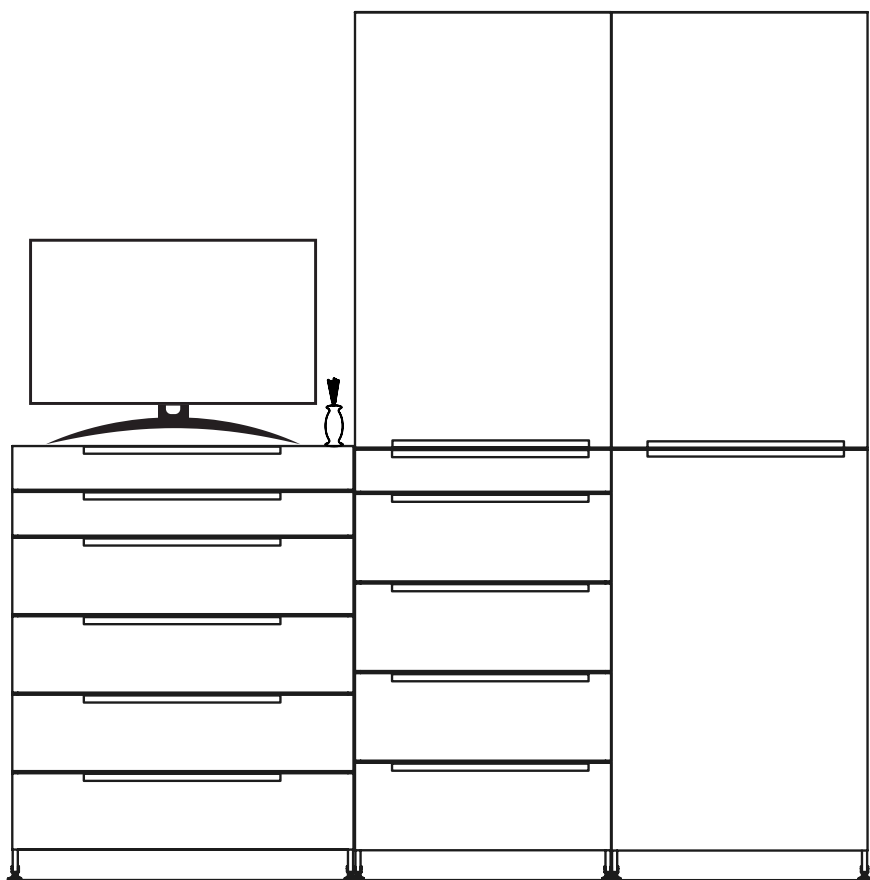
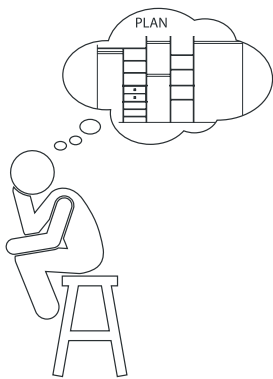



capelli®

Póliza de Garantía

5 años de
garantía

DISEÑO Y FUNCIONALIDAD

Industrias Llordec S.A. de C.V. garantiza los materiales de éste mueble por el término de **CINCO AÑOS** en todas sus partes y mano de obra, contra cualquier defecto de fabricación y funcionamiento a partir de la fecha _____.

Esta garantía es válida en condiciones de uso normal y bajo los lineamientos expresados en el instructivo correspondiente. No aplica en daños causados resultantes de una instalación inadecuada, mal uso, alteración, negligencia o accidente.

Industrias Llordec S.A. de C.V.

Antiguo Camino a Culhuacán No. 65

Col. Santa Isabel Industrial, Alcaldía Iztapalapa, CDMX. C.P. 09820

Tels. (55) 5670 4033 y (55) 5670 4412

Correo electrónico: contacto@capelli.com.mx

Página web: www.capelli.com.mx

Para hacer efectiva esta garantía:

- Comuníquese a nuestra línea de atención a clientes a los teléfonos: (55) 5670 4033, 800 5608 811
- Por e-mail a: contacto@capelli.com.mx
- Preséntese directamente en nuestras oficinas con su ticket de compra o factura y esta garantía

Gracias por su preferencia



Cuidado y Mantenimiento del Producto



Los muebles están expuestos a continuos cambios y por ello es necesario ofrecerles algunos cuidados. Si quiere sacar el mayor provecho de sus muebles y que luzcan como el primer día, deberá seguir nuestras recomendaciones y dar un mantenimiento continuo.

La humedad y temperatura



- Debemos procurar que las condiciones de humedad y temperatura a las cuales sea expuesto el mueble sean lo más estables posible. El exceso en la humedad y temperatura pueden provocar deformaciones en el material.
- Evite el contacto directo con estufas, radiadores o cualquier fuente de calor.
- Evite derramar líquidos en las superficies no protegidas por el recubrimiento.

El polvo



- Es habitual que se acumule polvo sobre la superficie de los muebles. Para evitar rayar el mueble, es importante utilizar un paño suave, puede estar humedecido con agua o un producto no abrasivo especializado para la limpieza de muebles de madera.
- Recordemos siempre retirar el exceso de humedad con un paño seco.

Desmontaje de los muebles



- No recomendamos el montaje y desmontaje recurrente de los muebles, ya que nuestros productos están diseñados para ser armados una única vez.
- Es muy importante leer y atender el instructivo de forma consecutiva y ordenada para el correcto armado de su mueble.
- Es importante contar con ayuda y la herramienta adecuada que se especifica en el instructivo.

Recomendaciones generales



- Evite colocar objetos puntiagudos sobre la superficie de los muebles.
- Ajuste periódicamente los herrajes.
- Para mover el mueble de lugar, cárguelo, no lo empuje ni arrastre.
- Mantenga el mueble siempre nivelado para garantizar un buen funcionamiento de puertas y cajones.



Hecho en México por:
Industrias Llordec S.A. de C.V.
Antiguo camino a Culhuacán No. 65
Col. Sta. Isabel Industrial,
Alcaldía Iztapalapa, Ciudad de México,
C.P. 09820



 800 5608-811

 contacto@capelli.com.mx

 www.capelli.com.mx

 /capellimx

 capellimx