

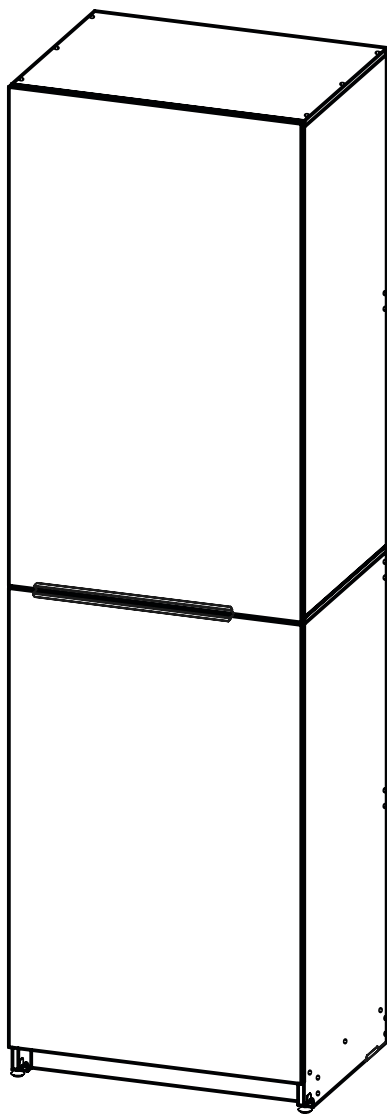

# DOBLE COLGADOR



**capelli**<sup>®</sup>  
diseño y funcionalidad

Gracias por adquirir nuestros productos. Por favor, **lea todo el instructivo ANTES** de comenzar el armado de su nuevo mueble.

## Contenido de la Caja

TA	Tapa	1 pz
CSD	Costado Sup. D	1 pz
CSI	Costado Sup. I	1 pz
ED	Entrepaño Div.	1 pz
CID	Costado Inf. D	1 pz
CII	Costado Inf. I	1 pz
BA	Base	1 pz

PS	Puerta Superior	1 pz
PI	Puerta Inferior	1 pz
ZO	Zoclo	2pz
ZM	Zoclo Medio	3 pz
FO	Forro	1 pz
FI	Forro Inferior	1 pz

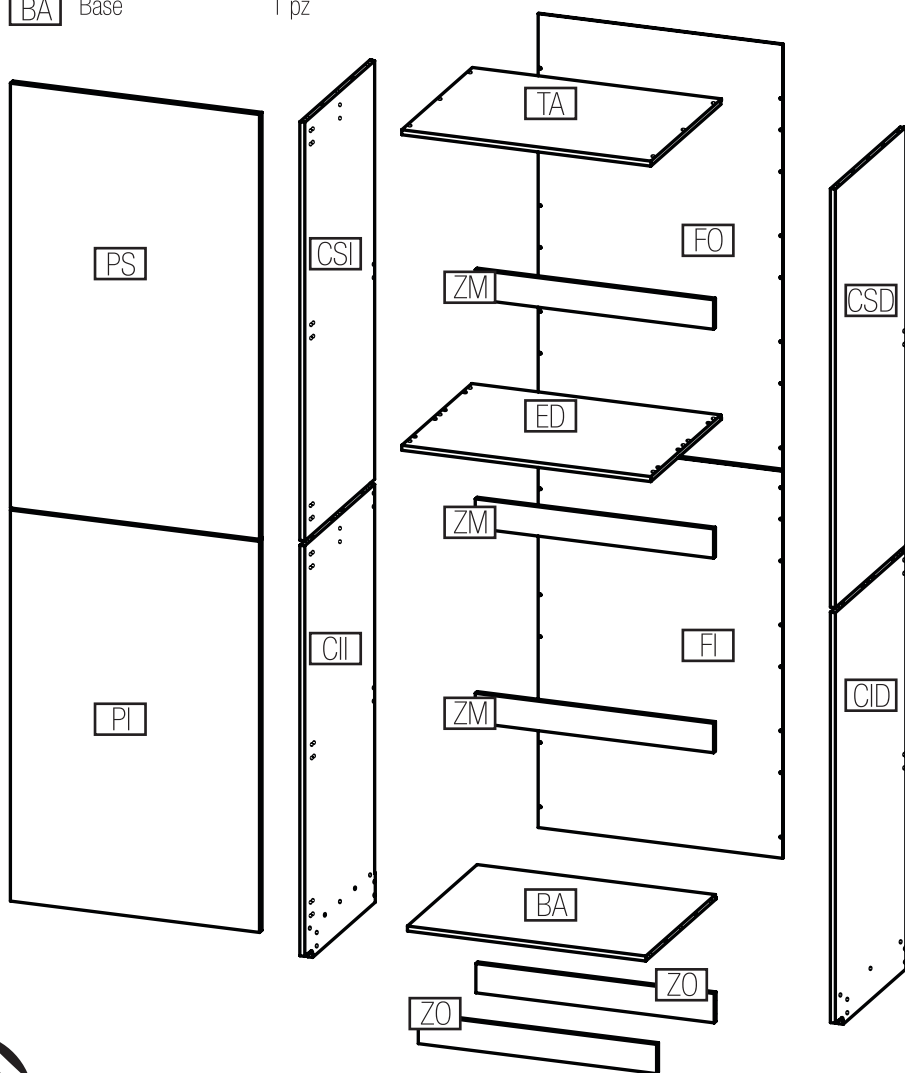

# Herrajes



01  
06pz  
Caja minifix  
12mm

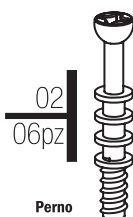

02  
06pz  
Perno  
galvanizado 24mm

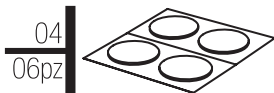

04  
06pz  
Etiqueta para Minifix  
12mm



09  
08pz  
Taquete de  
madera 6x30mm

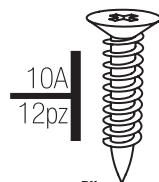

10A  
12pz  
Pija  
6x5/8"

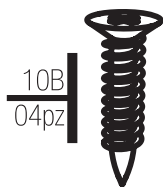

10B  
04pz  
Pija  
6x5/8" Negra



11  
32pz  
Clavo

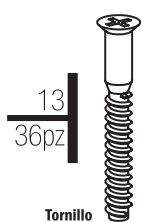

13  
36pz  
Tornillo  
Confirmat 5x38mm

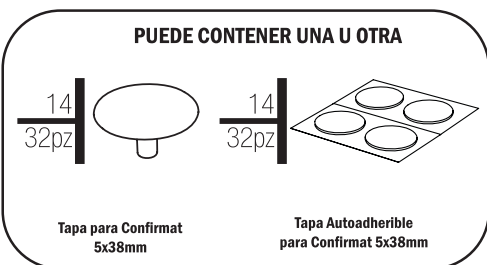

PUEDA CONTENER UNA U OTRA

14  
32pz  
Tapa para Confirmat  
5x38mm

14  
32pz  
Tapa Autoadherible  
para Confirmat 5x38mm

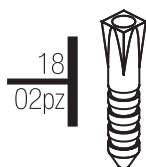

18  
02pz  
Taquete Plástico  
1/4"

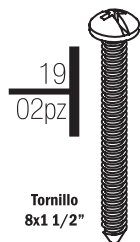

19  
02pz  
Tornillo  
8x1 1/2"



23  
04pz  
Brida Negra

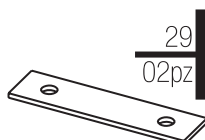

29  
02pz  
Placa de Unión

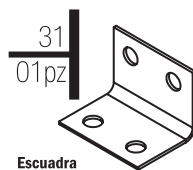

31  
01pz  
Escuadra  
metálica

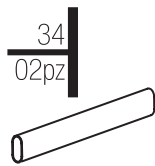

34  
02pz  
Tubo Ovalado  
567mm Negro

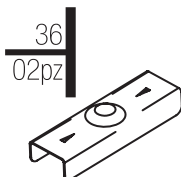

36  
02pz  
Resbalon  
Metálico 12mm

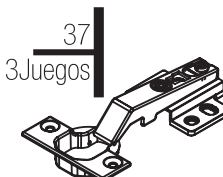

37  
3Juegos  
Bisagra  
Sobrepueta



38  
02pz  
Jaladera Platino  
Negra

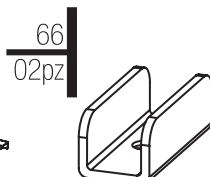

66  
02pz  
Soporte Nivelador

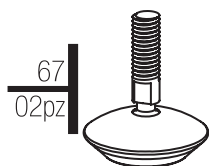

67  
02pz  
Tornillo  
Nivelador

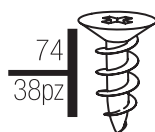

74  
38pz  
Tornillo Griper  
6 x 1/2"



83  
04pz  
Goma Antigolpes

# Herramientas Necesarias

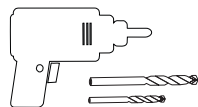
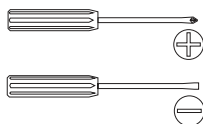
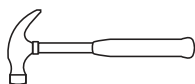

# Recomendaciones Generales



Lea este instructivo en su totalidad antes de iniciar el armado de su mueble.

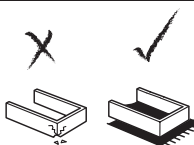

Proteja su superficie de trabajo para evitar dañar el acabado del mueble.

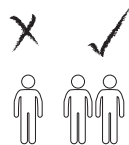

Pida ayuda. Este mueble está diseñado para armarse entre 2 personas.

# I

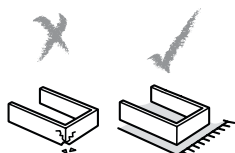

Materiales:

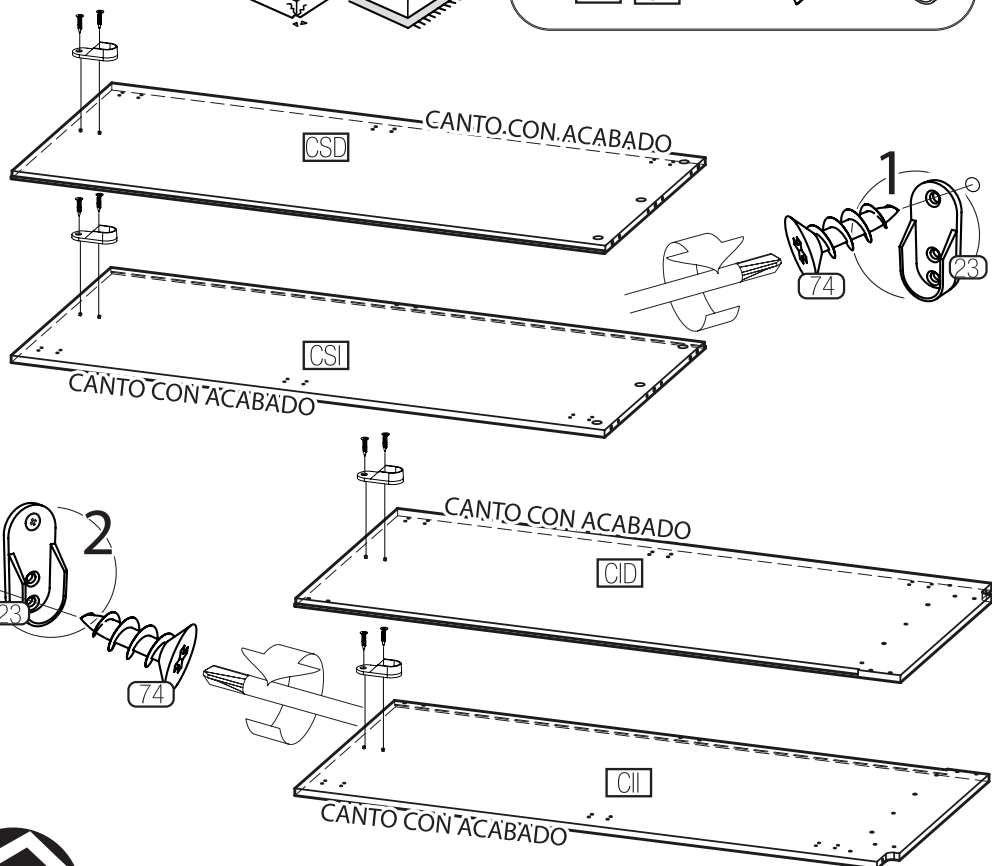

# 2

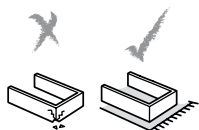

Materiales:

BA

09  
04pz

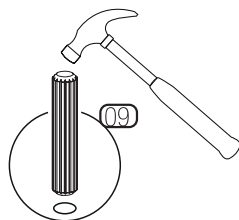
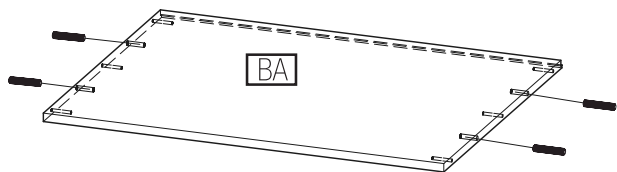

# 3

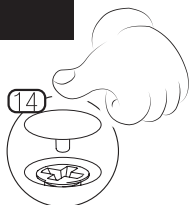

Materiales:

CID

ZO X2

13  
22pz

CII

ZM X2

14  
22pz

BA

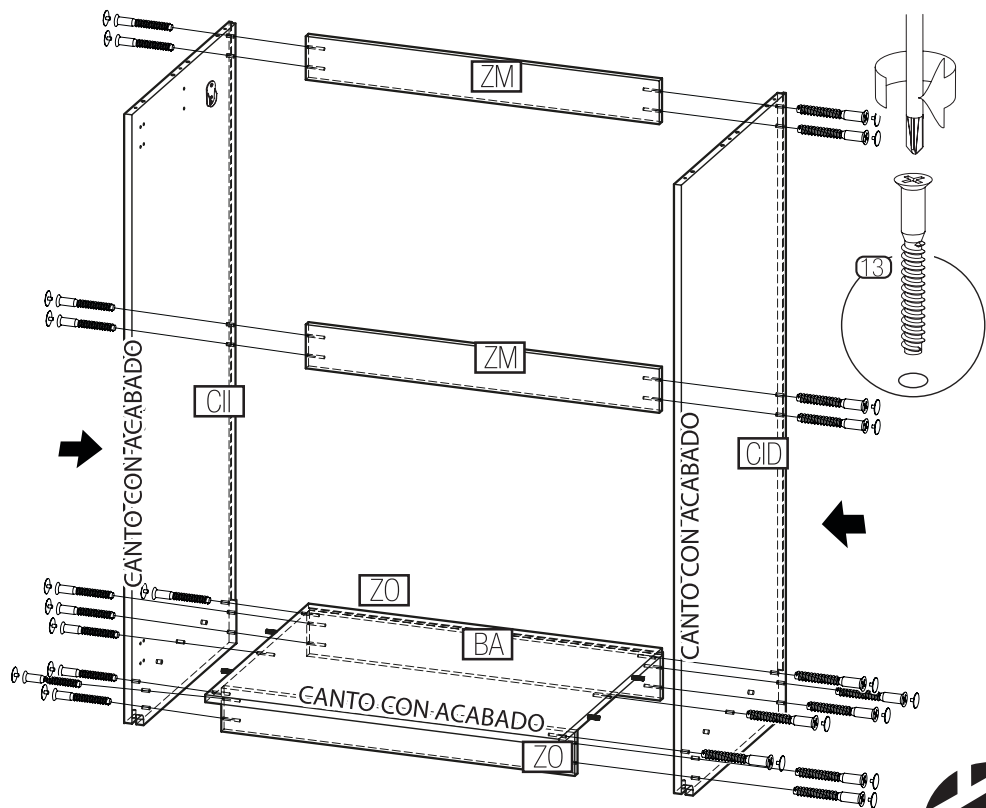

# 5

4

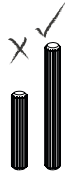
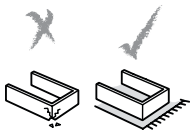

Materiales:

ED	13	
	04pz	

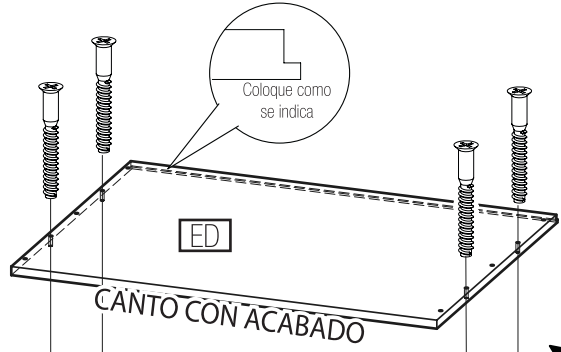
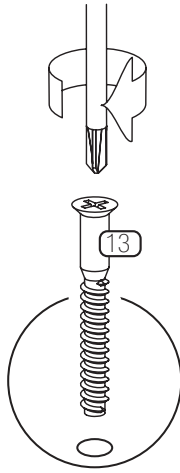

CANTO CON ACABADO

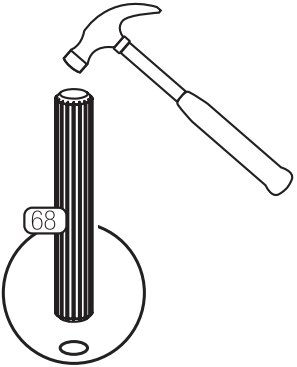
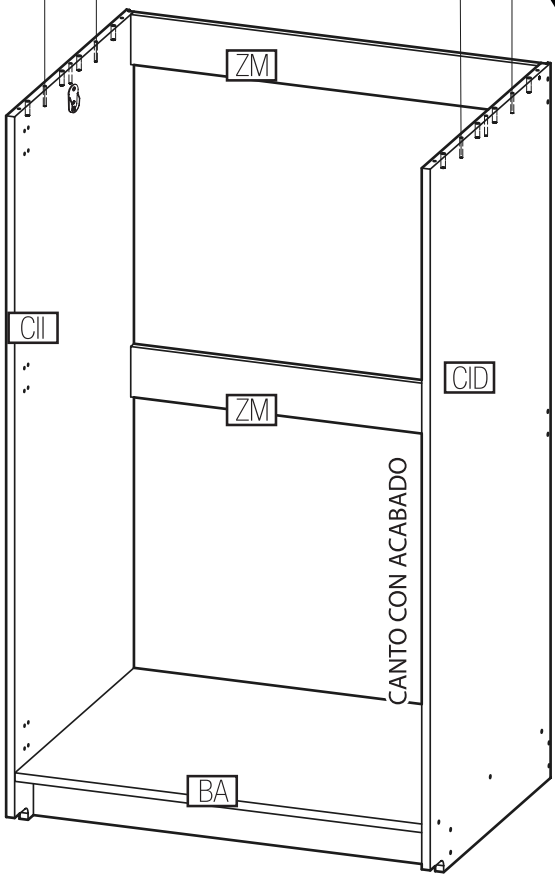

# 5

Materiales:

02  
06pz

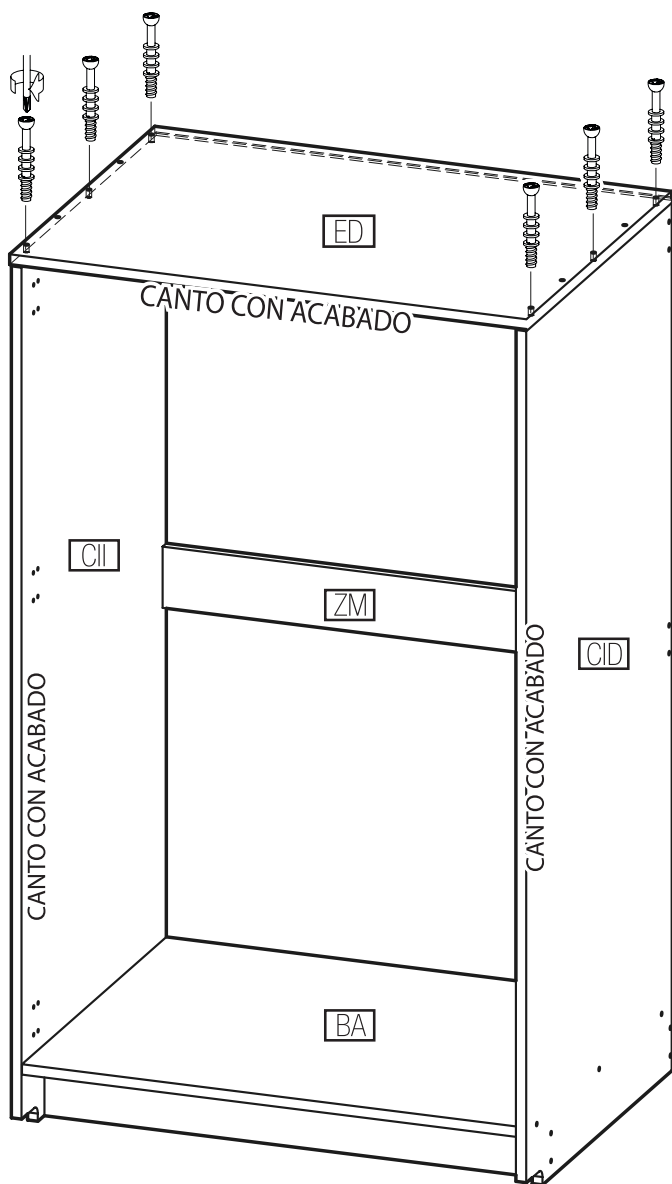
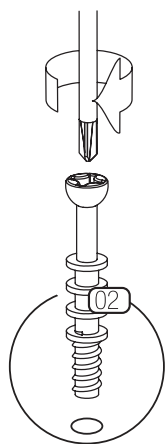
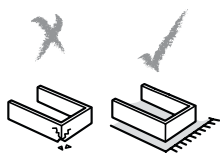
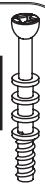

6

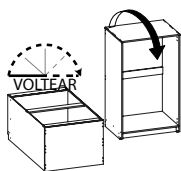

Materiales:

FO 11  
16pz

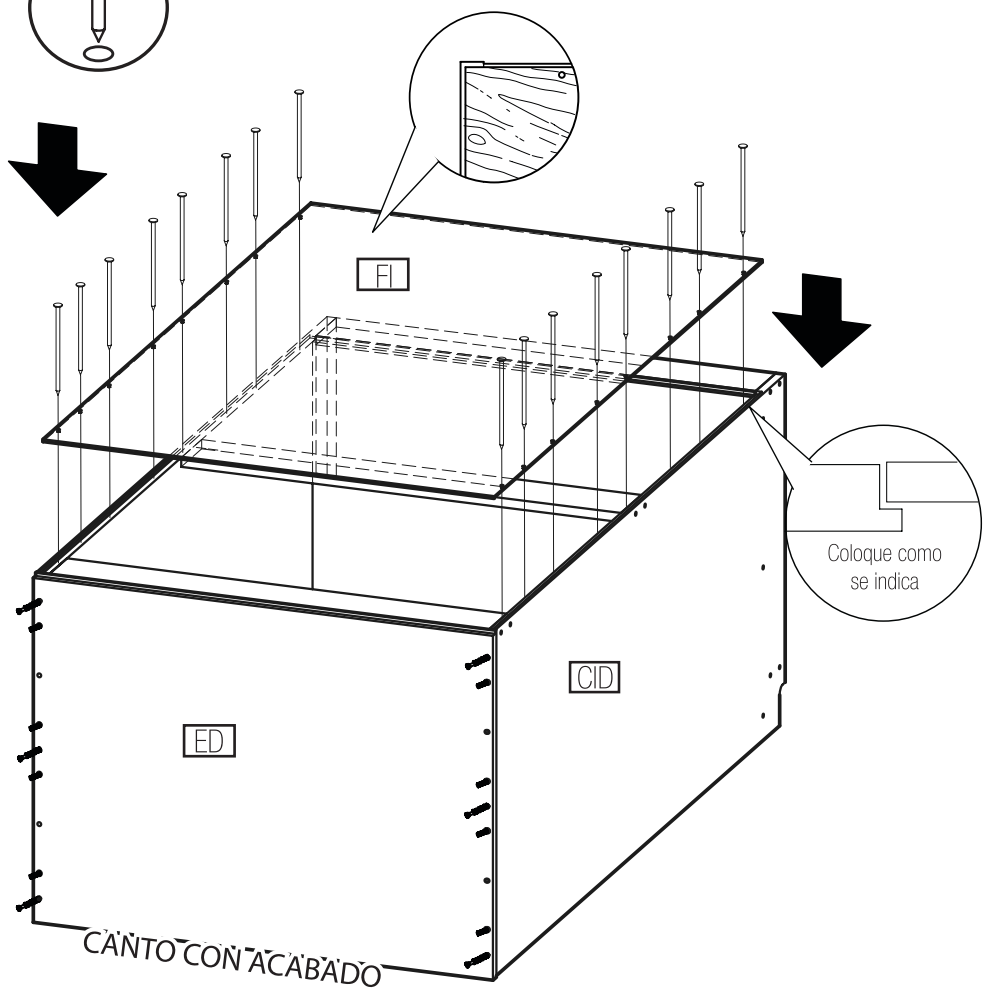
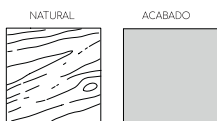
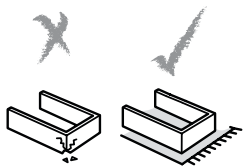
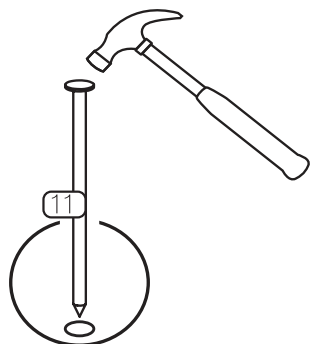

CANTO CON ACABADO

8

7

Materiales: 36  
02pz

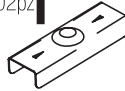

66  
02pz

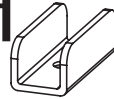

67  
02pz

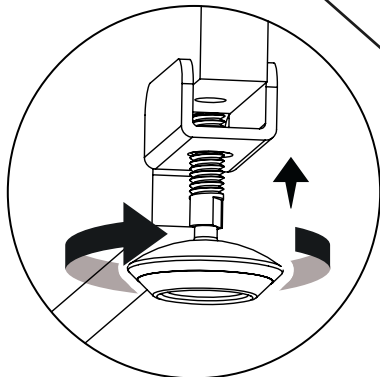
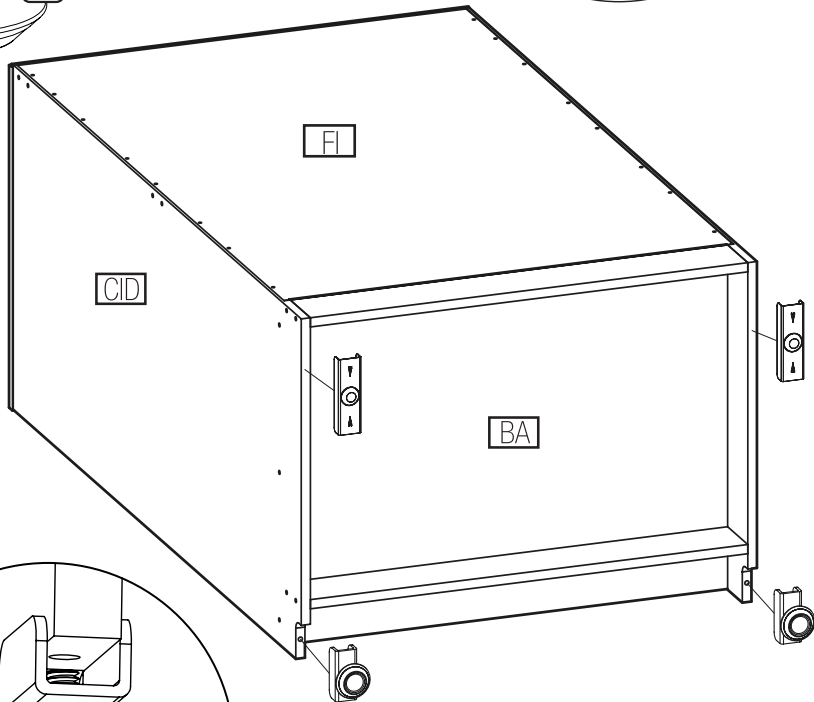
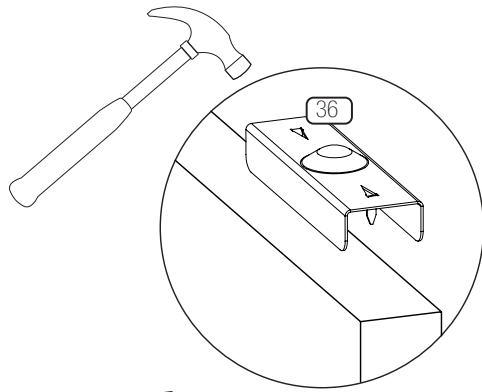
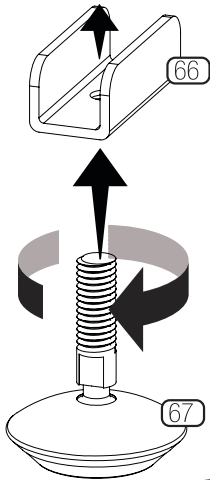
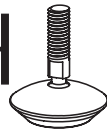

Materiales:

CSD

CSI

ZM

14  
04pz



13  
04pz



09  
04pz

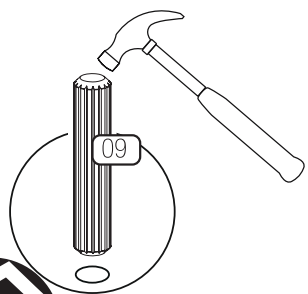
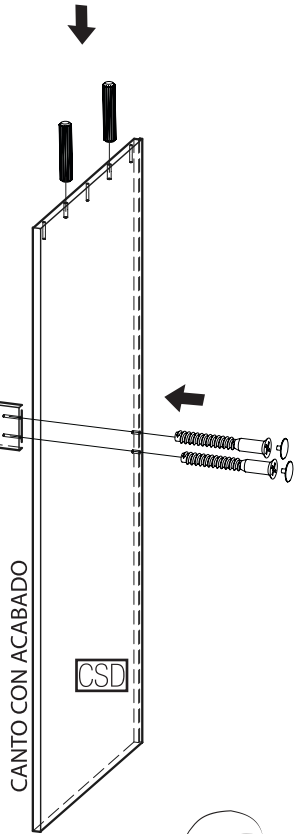
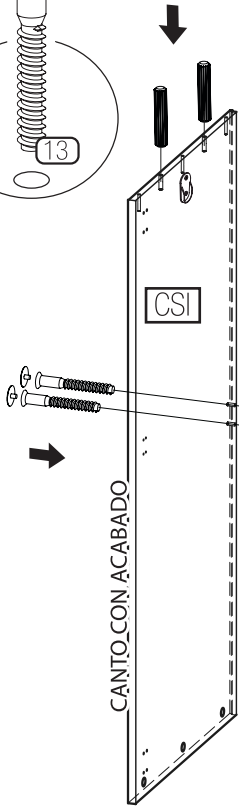
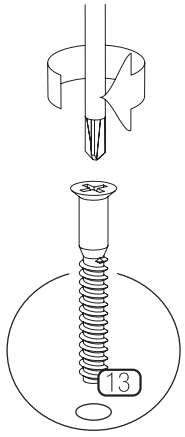

9

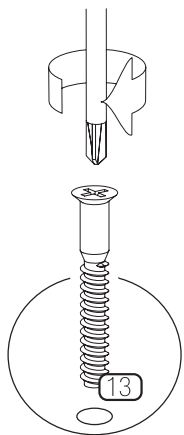

Materiales: TA

13  
06pz



14  
06pz

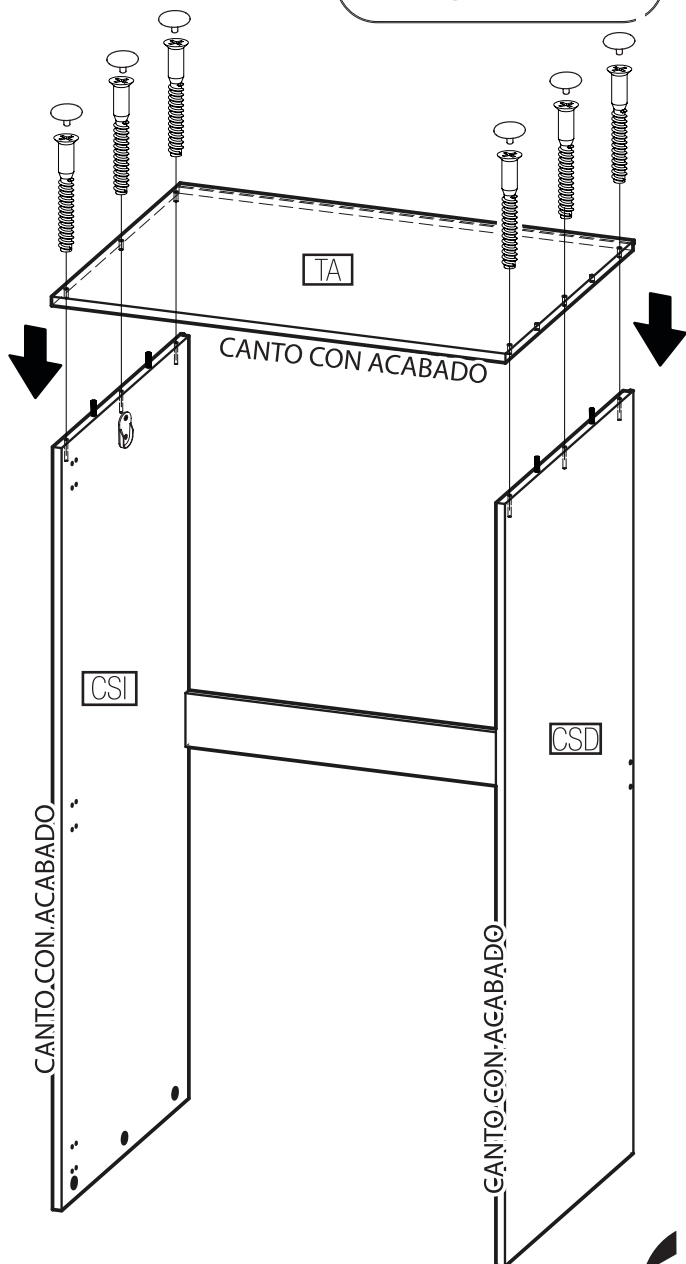

# 10

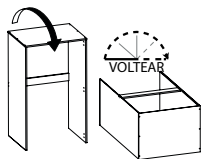

Materiales:

FO 11  
16pz

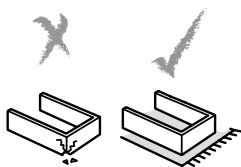
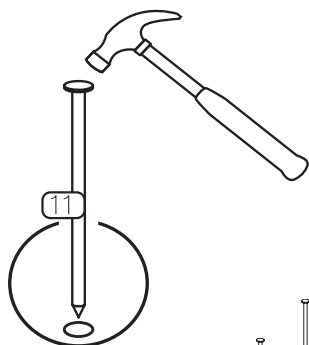

NATURAL

ACABADO

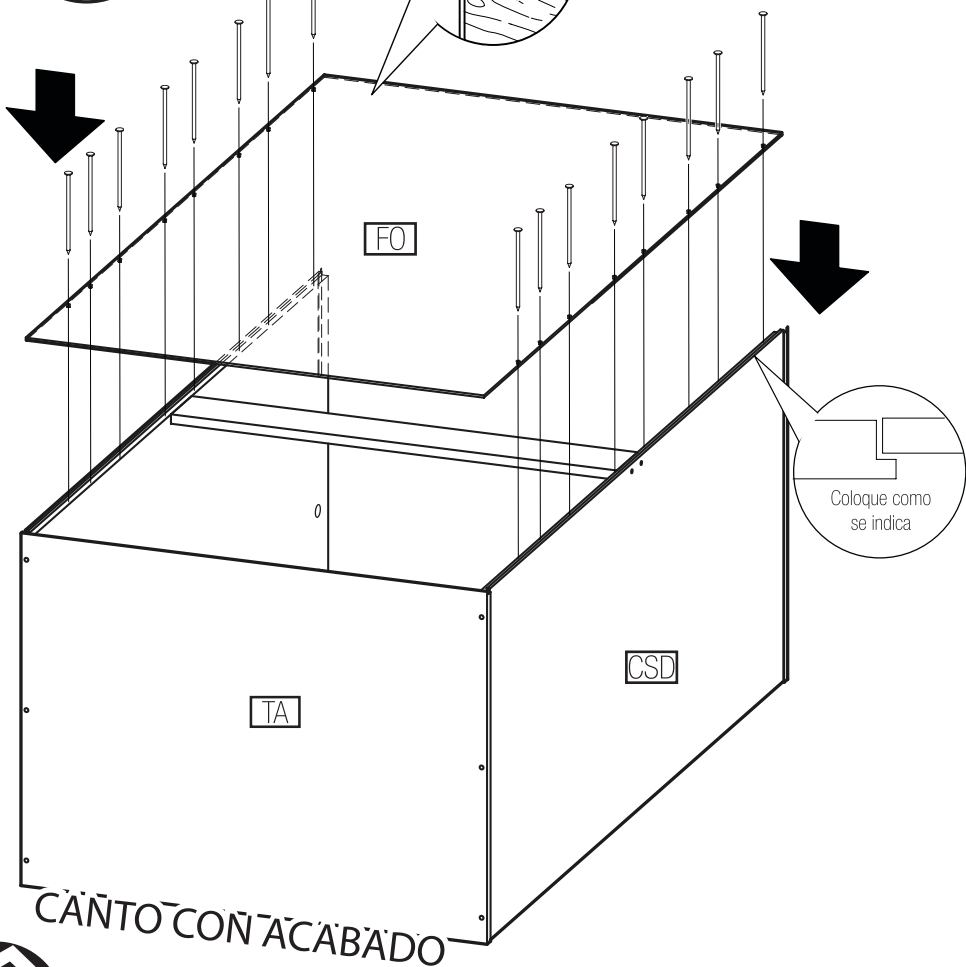
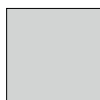
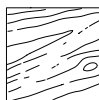

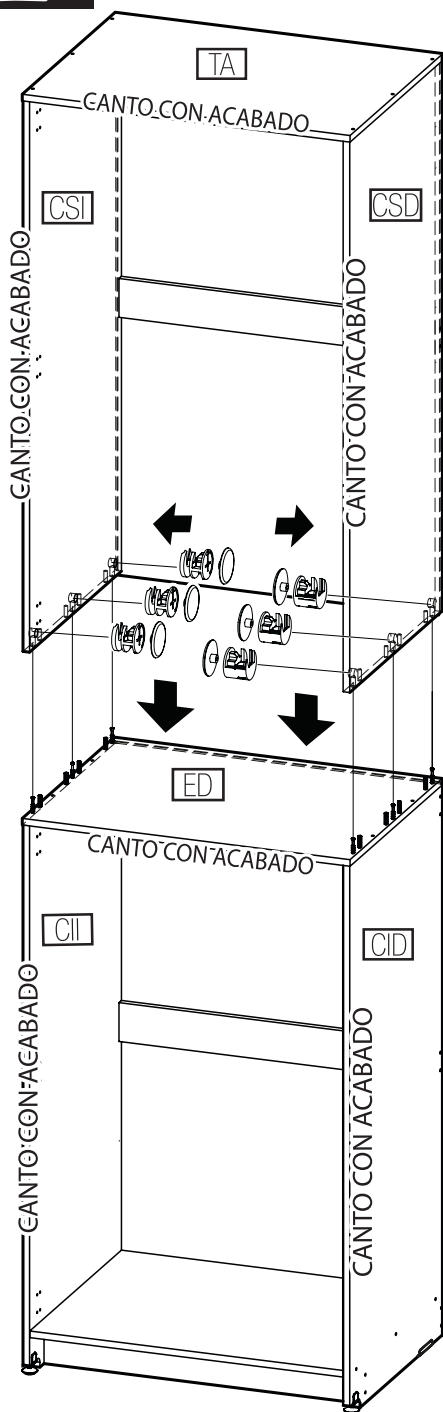

Materiales:



1 Colocar minifix con la flecha apuntando hacia el perno

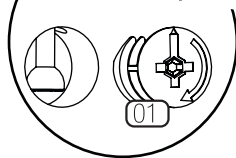

2 Atornillar hacia la derecha 95°

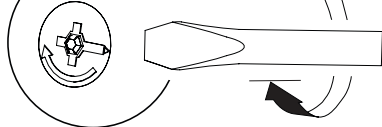

3 Colocar tapa

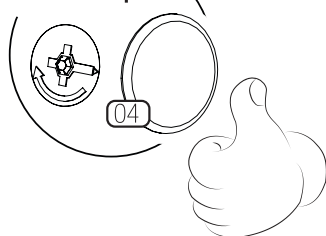

# 1 2

Materiales:

3 4  
02pz

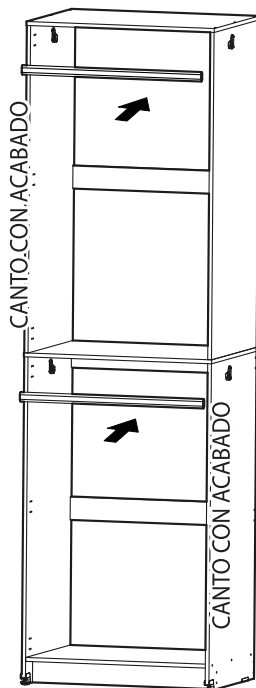
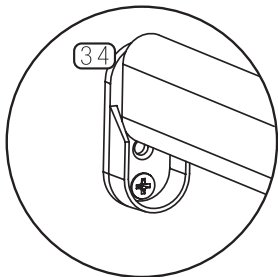

# 1 4

Materiales:

P S  
P

3 7  
3Juegos



1 0 A  
12pz



**NO** usar atornillador eléctrico

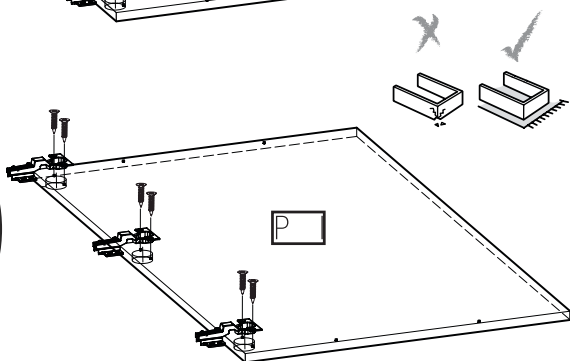
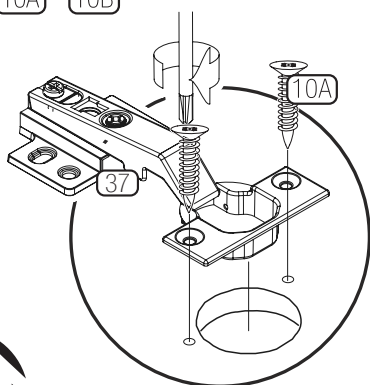
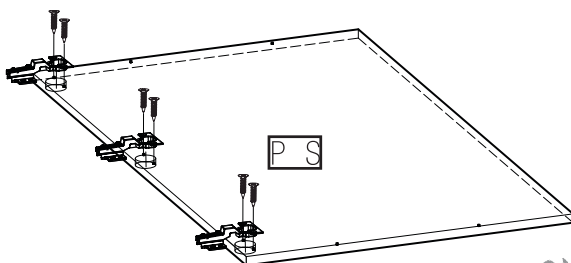
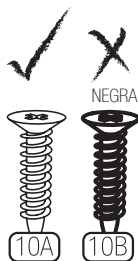

# 1 3

Materiales:



3 8  
02pz



10B  
04pz



8 3  
04pz

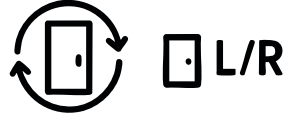
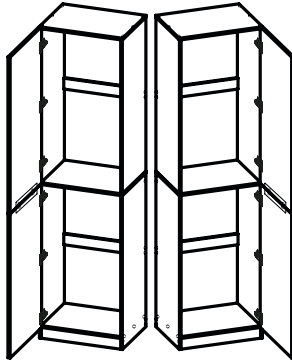

Puerta reversible:  
Es posible colocarla del  
lado derecho o izquierdo  
Se adapta a tu espacio

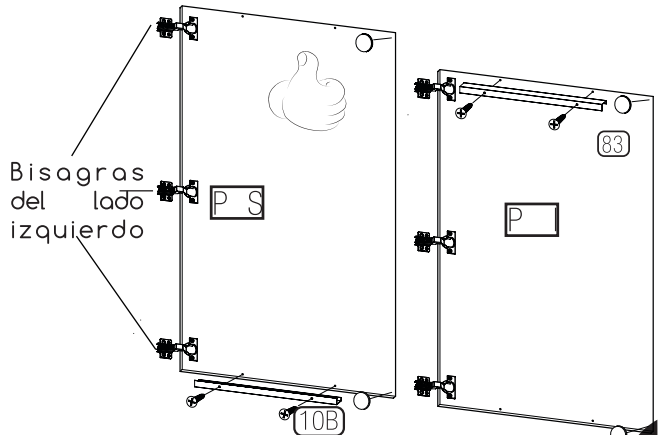
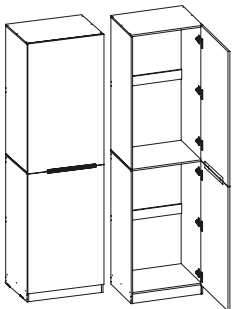
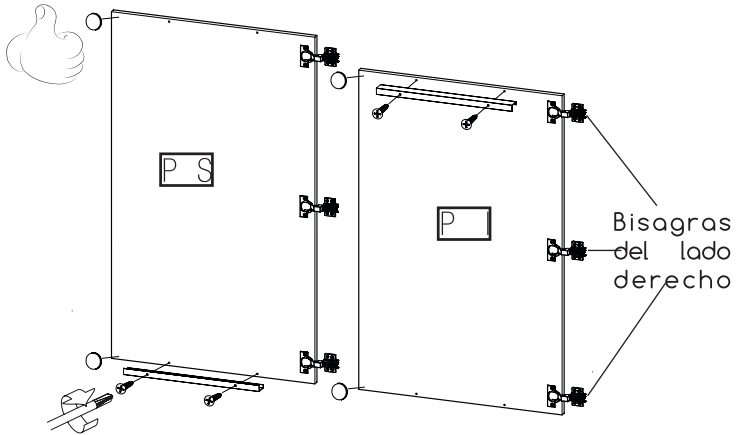
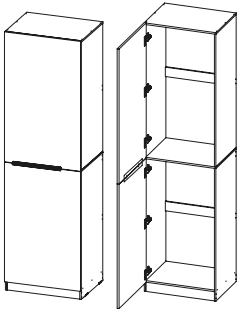

# 15

Materiales:

74  
24pz



Ajuste de puertas

## AJUSTE LAS BISAGRAS

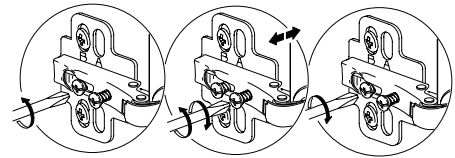
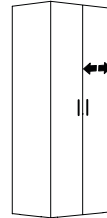
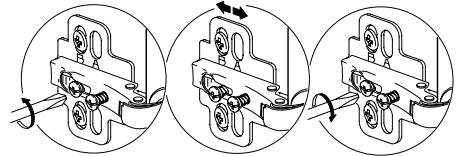
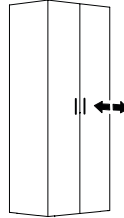
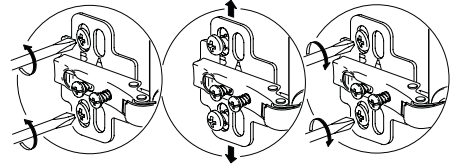
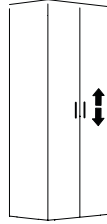

**Repetir este paso para las dos puertas**

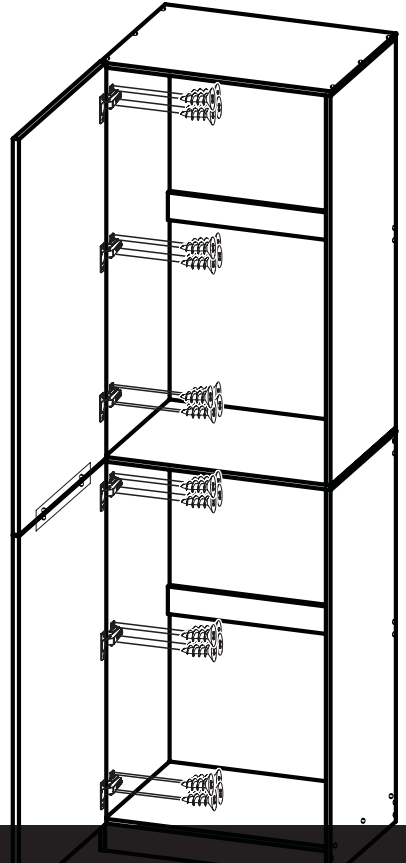
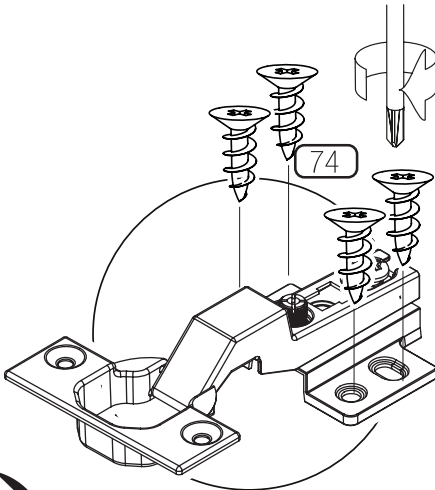

16

# Montaje a pared

## Paso 1

Marque la pared con un lápiz.

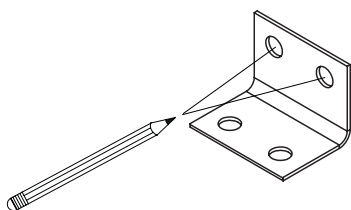

Materiales:

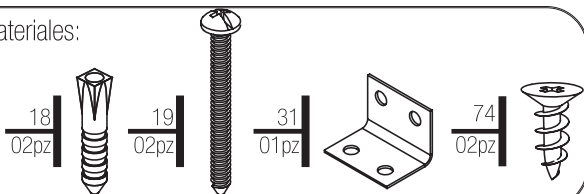

## Paso 2

Barrene la pared con una broca de 1/4". Posteriormente, haga un pequeño barreno guía de poca profundidad en la tapa del clóset con una broca delgada.

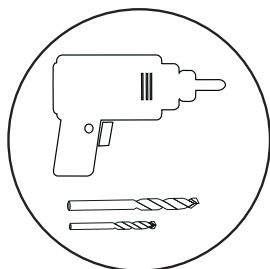

## Paso 3

Inserte los taquetes en la pared.

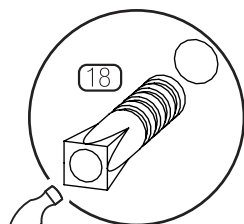

## Paso 4

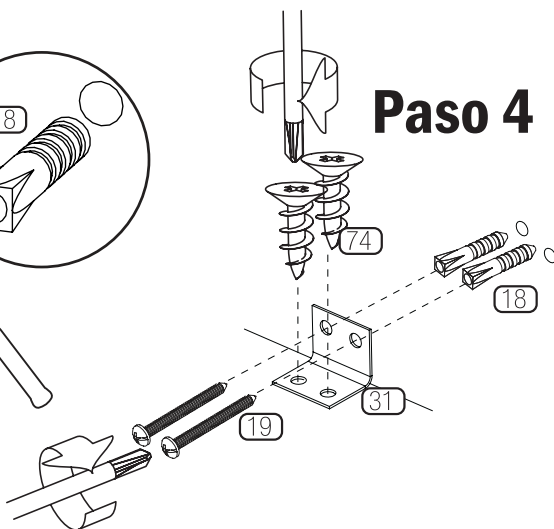

Los herrajes de anclaje incluidos en la caja están diseñados para muros convencionales de tabique rojo. Consulte a un experto para instalación en muros de otros materiales.

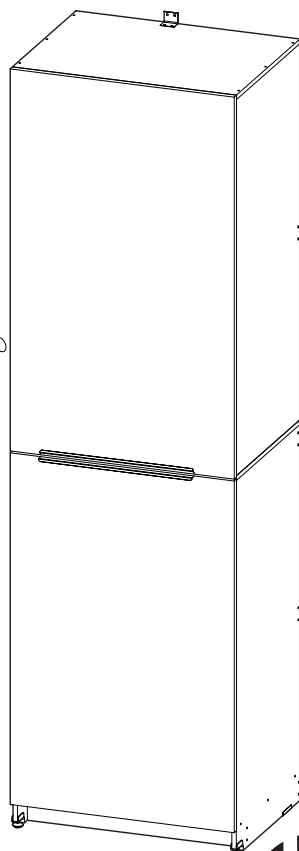

# Unión

En caso de haber adquirido más de un módulo de la **Línea Platino** debe unirlos con las placas de fijación y las pijas como se muestra en el dibujo. ¡Disfruta de tu nuevo mueble!

Materiales:

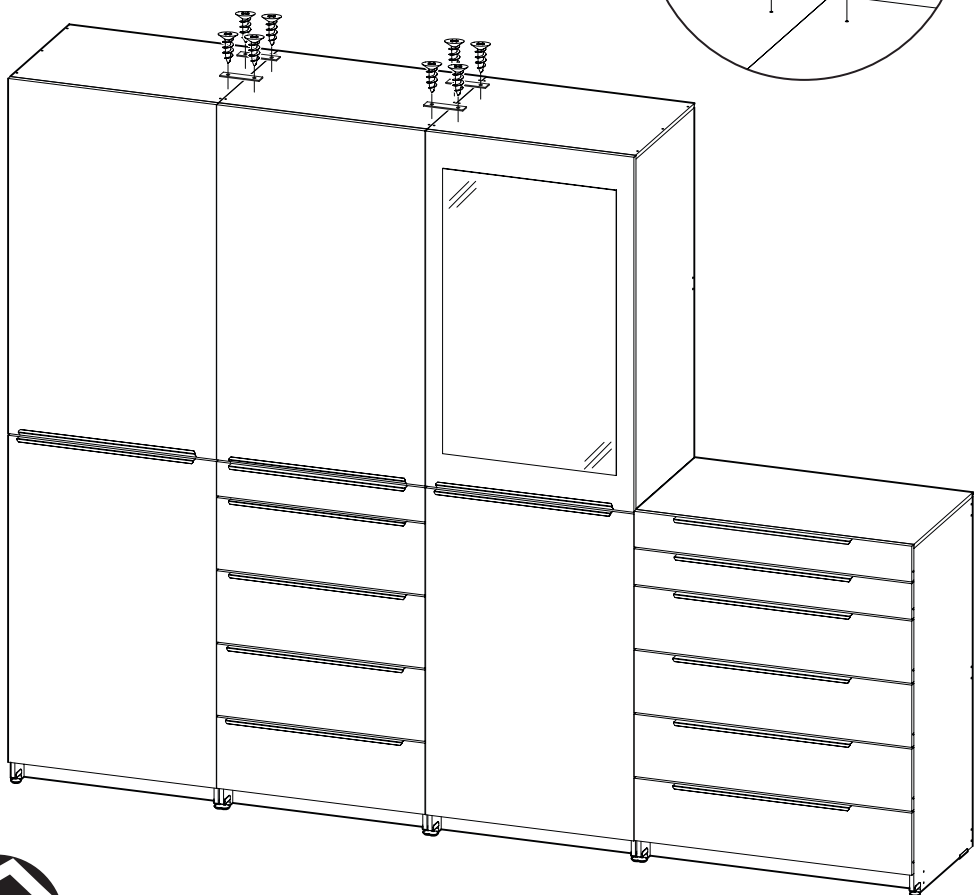
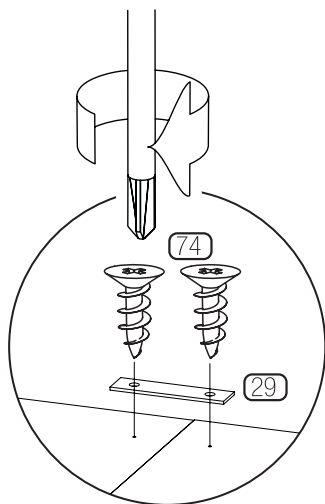
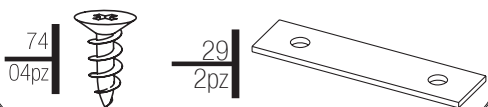

# Configuraciones

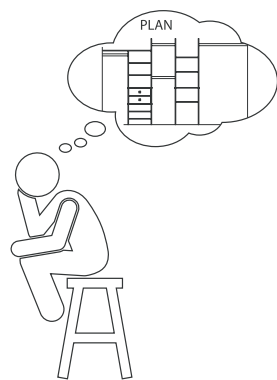

# Configuraciones

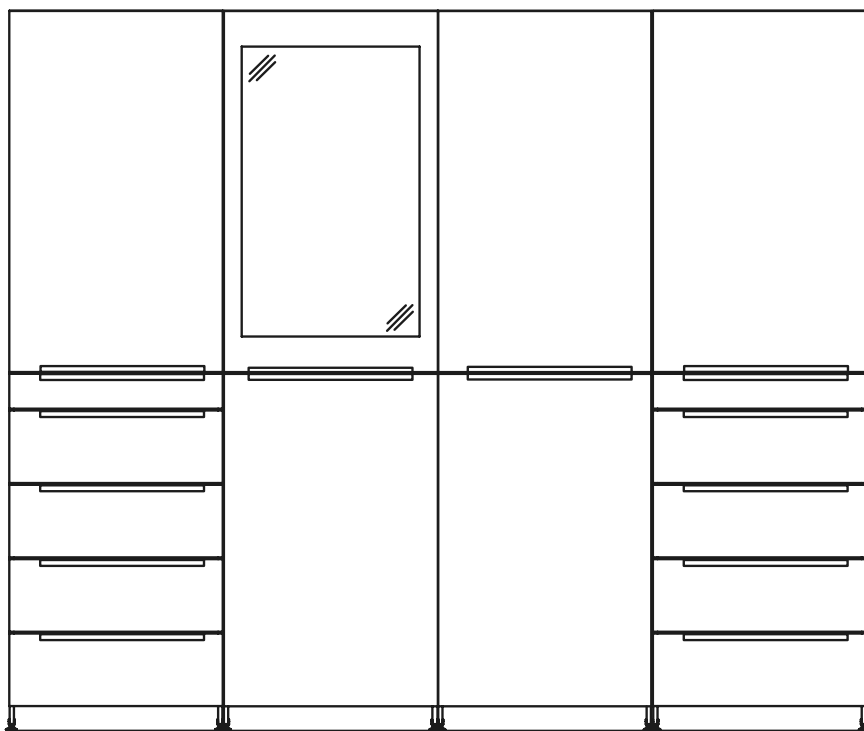
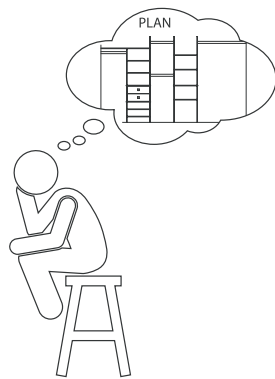

# Configuraciones

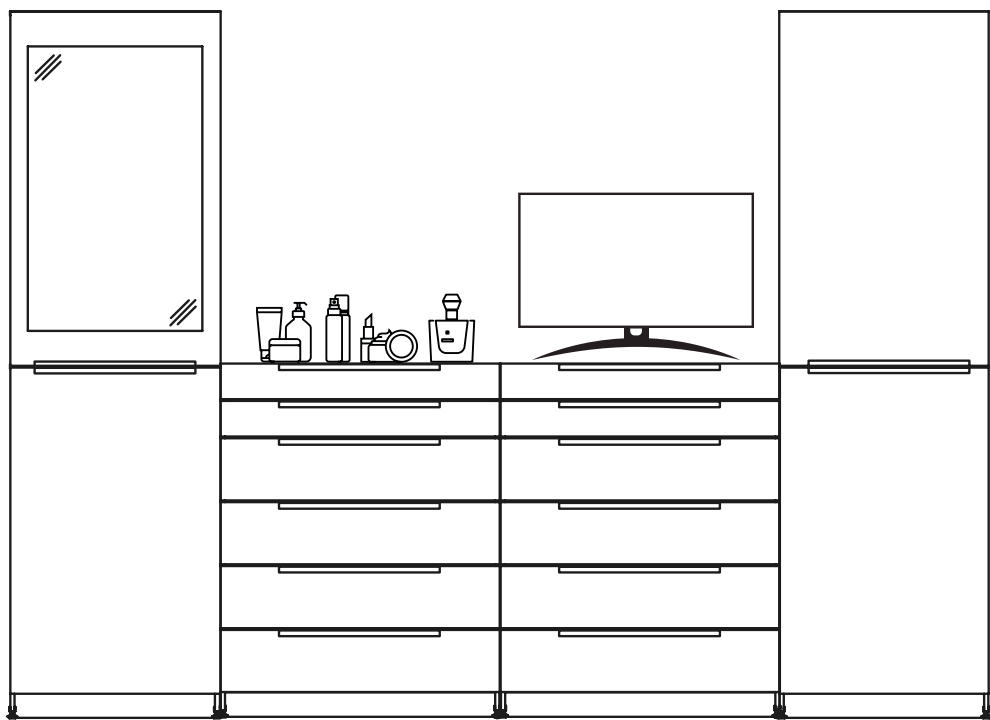
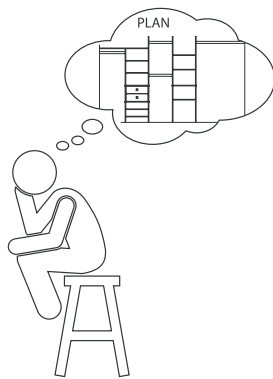

# Configuraciones

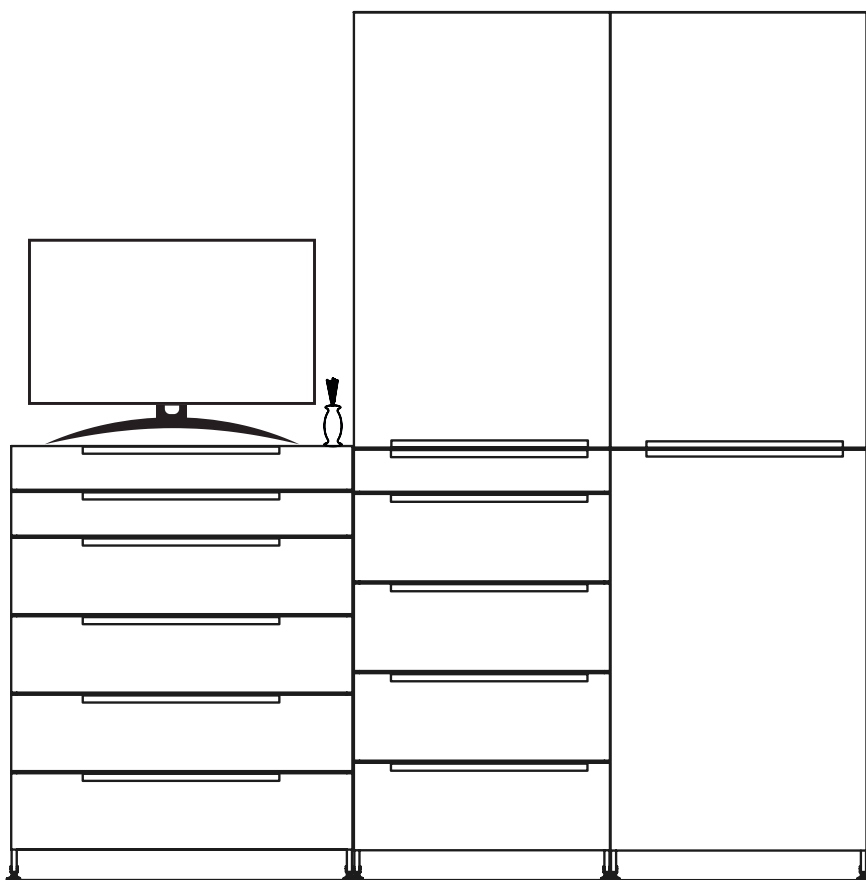
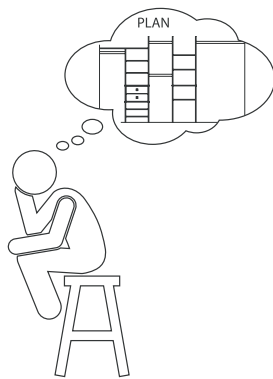



capelli®

## Póliza de Garantía

5 años de  
garantía

### DISEÑO Y FUNCIONALIDAD

Industrias Llordec S.A. de C.V. garantiza los materiales de éste mueble por el término de **CINCO AÑOS** en todas sus partes y mano de obra, contra cualquier defecto de fabricación y funcionamiento a partir de la fecha \_\_\_\_\_

Esta garantía es válida en condiciones de uso normal y bajo los lineamientos expresados en el instructivo correspondiente. No aplica en daños causados resultantes de una instalación inadecuada, mal uso, alteración, negligencia o accidente.

### Industrias Llordec S.A. de C.V.

Antiguo Camino a Culhuacán No. 65

Col. Santa Isabel Industrial, Alcaldía Iztapalapa, CDMX. C.P. 09820

Tels. (55) 5670 4033 y (55) 5670 4412

Correo electrónico: [contacto@capelli.com.mx](mailto:contacto@capelli.com.mx)

Página web: [www.capelli.com.mx](http://www.capelli.com.mx)

Para hacer efectiva esta garantía:

- Comuníquese a nuestra línea de atención a clientes a los teléfonos: (55) 5670 4033, 800 5608 811
- Por e-mail a: [contacto@capelli.com.mx](mailto:contacto@capelli.com.mx)
- Preséntese directamente en nuestras oficinas con su ticket de compra o factura y esta garantía

**Gracias por su preferencia**



# Cuidado y Mantenimiento del Producto



Los muebles están expuestos a continuos cambios y por ello es necesario ofrecerles algunos cuidados. Si quiere sacar el mayor provecho de sus muebles y que luzcan como el primer día, deberá seguir nuestras recomendaciones y dar un mantenimiento continuo.

## La humedad y temperatura



- Debemos procurar que las condiciones de humedad y temperatura a las cuales sea expuesto el mueble sean lo más estables posible. El exceso en la humedad y temperatura pueden provocar deformaciones en el material.
- Evite el contacto directo con estufas, radiadores o cualquier fuente de calor.
- Evite derramar líquidos en las superficies no protegidas por el recubrimiento.

## El polvo



- Es habitual que se acumule polvo sobre la superficie de los muebles. Para evitar rayar el mueble, es importante utilizar un paño suave, puede estar humedecido con agua o un producto no abrasivo especializado para la limpieza de muebles de madera.
- Recordemos siempre retirar el exceso de humedad con un paño seco.

## Desmontaje de los muebles



- No recomendamos el montaje y desmontaje recurrente de los muebles, ya que nuestros productos están diseñados para ser armados una única vez.
- Es muy importante leer y atender el instructivo de forma consecutiva y ordenada para el correcto armado de su mueble.
- Es importante contar con ayuda y la herramienta adecuada que se especifica en el instructivo.

## Recomendaciones generales



- Evite colocar objetos puntiagudos sobre la superficie de los muebles.
- Ajuste periódicamente los herrajes.
- Para mover el mueble de lugar, cárguelo, no lo empuje ni arrastre.
- Mantenga el mueble siempre nivelado para garantizar un buen funcionamiento de puertas y cajones.



Hecho en México por:  
Industrias Llordec S.A. de C.V.  
Antiguo camino a Culhuacán No. 65  
Col. Sta. Isabel Industrial,  
Alcaldía Iztapalapa, Ciudad de México,  
C.P. 09820



 800 5608-811

 contacto@capelli.com.mx

 www.capelli.com.mx

 /capellimx

 capellimx